

Price List 2026

rhbr



Welcome to rhbr, the trading name for Rhubarb Seating Limited

rhbr designs and manufactures seating for every non-domestic environment. Our approach is founded on core principles which have the needs and interests of our customers at their heart.

Delivering what your project needs: we manufacture every product ourselves, NO element is sub-contracted, and all our soft seating is designed in-house. That means that if our standard products are not quite what is needed, we will create something from scratch or change the dimensions to fit.

Flexibility:

- Lead times – if you really need it in a hurry we can usually help
- Delivery schedules – we know projects do not always go to plan so we will be here to work with you to flex arrangements
- Support – whatever you need we will do our utmost to accommodate it, from product modification to warehousing for stock that can't be delivered to site
- Advice – on fabrics, foams, product construction to make sure you and your clients get the best solutions

Space planning: we are able to provide full space planning services where they will add value

Sustainability and social responsibility: we are proactively pursuing an agenda to net zero. We are members of the SME Climate Hub and sit on its Global Steering Committee and hold a number of other relevant sustainability accreditations including ISO14001 and FSC® Chain of Custody. We have been recognised as leaders in the circular economy in our industry. We also provide community support for various organisations.

We pride ourselves on the quality of our work and on our personal approach to business and the relationships that underpin it.



How to get the best from rhbr

We hope this document will give you the information you need to select the right product for you or your customer's requirements; however, if you need any other information, or you can't find exactly what you are looking for, there may be other options.

Remember: as a manufacturer with our own in-house design team, we can produce bespoke solutions to fit specific needs or environments.

We regularly add to our portfolio so if you can't find exactly what you are looking for have a look at the website, or better still...

..call us. We are here to help.

01869 326300.

Price

The prices included here are our Recommended Retail Prices at the date of publication. Sadly, geopolitical uncertainties, in particular the current situation in the Middle East, are giving rise to price increases in certain raw materials which are too large for us to absorb. Our quotations may, therefore, include a surcharge which will be subject to fluctuation, either up or down, depending on the timing of order/delivery and the actual raw materials prices at that point. As always, we have done our utmost to restrict price increases to a minimum by constantly driving efficiencies in our manufacturing processes.

What range?

On the following pages you will see we have made some suggestions as to what ranges suit certain environments and we have also listed our products by use.

What product?

Each product page starts with a summary of the standard benefits and features of the range.

What fabric and colour?

Fabrics are grouped into price bands and priced individually for each product. On page 177 you will find a guide on choosing the right fabric for you and on our website we have a comprehensive fabric guide.

Fabric really does make a difference – both in terms of quality and rating and in terms of colour and design – so if you are in any doubt do call us to discuss your options. From our years of experience, we can recommend appropriate fabrics for certain seat types and environments and if we say we don't recommend a covering for a certain type of chair it is because we know it really does not work.

What price?

Order quantities have a huge impact on both manufacturing efficiency and logistics costs. It follows that the more you order, the greater the level of discount we are able to offer from our Recommended Retail Price. The discount structure we agree with you is our way of thanking you for your business and sharing the benefits of production and environmental efficiencies.

Ordering

You can email or post your orders. If you wish to place an order over the phone, we will ask you to confirm the details in writing as mistakes can be expensive for us all.

Please make sure you provide the product code, product size, any extras you wish to add and what finishes you require so we can make sure that what you receive is what you were expecting. Always add the price and don't forget we offer free delivery subject to the minimum order value and delivery location. We will provide you with an order acknowledgement as the final confirmation of your order details and this will form the basis of the contract for supply between us.

Deliveries

We hand-make all your furniture to order and we offer exceptionally quick deliveries, normally within 10 working days. All we ask is that you are ready for us. If for some reason you need to postpone delivery, please tell us as soon as you can so that we can stop making your products and won't have to charge you storage space.

We usually deliver on our own transport and to be effective we need to move on to our next customer, which may be you, quickly. Our drivers are not installation teams so we deliver to the ground floor point of entry. Please make sure you have appropriate staff on hand to accept delivery.

We take our environmental responsibilities seriously so do our best to reduce product miles and carbon footprint.

We are happy to quote for installation if this is a service you require.

Delivery charges

We do not charge for single drop deliveries of £1,000 and over within a specified list of postcodes which can be found on our website and are indicated within a red boundary line in the map on page 182. Deliveries within our boundary will be charged at £60 if the order value is below £1,000. Deliveries outside of the boundary will be charged at cost.

We design for green, not for the bin

The climate agenda has rapidly become a mainstream priority rather than a side-line and it is changing our attitudes and behaviours.

In our industry, that means people are increasingly looking for ways to reuse the furniture they have rather than throw it away and replace it with something new.

We are constantly amazed by the number of pieces we are asked to re-upholster that have been designed in a way that makes them incredibly difficult to refurbish because they can't easily be disassembled.

Here at rhbr, we design all our seating with sustainability in mind. Everything is made for the long term. Our cores and frames are robust with no compromises on the quality of the build, so when the fabric and the foams get tired or wear out, we can easily strip them back and refresh the whole look, just like new!

Our entire seating range is made to minimise component damage when stripped for refurbishment and therefore maximise reuse. We even consider how our products can be refurbished on-site to remove the need for costly and polluting transport to and from our factory.

Environmental Policy











We recognise that, as a manufacturer and supplier of office and contract chairs and tables, we have a responsibility to do what we can to make sure we do not contribute to further destruction of our environment. We want to lead by example and make rhbr a model company renowned for our environmental best practice; so we are continually working towards minimising our environmental impact and doing our utmost to reduce our environmental footprint to a tip toe!

To achieve our aims we will establish sound environmental management by:

- Ensuring that, as a minimum requirement, we conduct our operations in full compliance with all relevant legislation, regulations and environmental codes of practice applicable to our operations, so as to minimise any pollution of the environment.
- Protecting the environment from our activities, including prevention of pollution
- Seeking to continually improve our environmental performance and our environmental management system by setting and reviewing environmental aspects, objectives and targets, making environmental improvements and monitoring performance by regular review
- Considering any environmental issues as part of our normal decision making process
- Developing a relationship with suppliers and contractors and encourage them to manage their environmental impacts more effectively
- Reviewing this Environmental Policy at least annually, or when there are any significant changes either to our operations or to environmental legislation.
- Our immediate environmental objectives are:
 - Waste reduction and recycling
 - Sustainable sourcing and product
 - Maximum energy efficiency
- This policy will be made available to all interested parties on request.

Contents

Soft Seating | Sofas, Armchairs & Lounge Chairs

	Cantay - NEW	15
	Harlan	17
	Hoxton and Hoxton Lux	19
	Kendra and Kendra Lux	21
	Kira	23
	Marna	27
	Nara	29
	Nova	31
	Horizon	33
	Rama	33
	Varda & Varda Footstool	35



Soft Seating | Modular Seating

	Beanbag 2.0	39
	Kolbak	41
	Stella	45
	Zeta	48

Soft Seating | Banquette Seating

	The Banq - NEW	59
--	----------------	----

Soft Seating | Booth Seating

	Kolbak Booth	89
	Rondo Booth	91
	Zeta Booth	93



Soft Seating | Stools

	Jupiter	97
	Valbo	99

Soft Seating | Seating for Kids

	Beanbag	104
	Dice/Cube	104
	Toadstool	105
	ZigZag	107





Ancillary

	Laptop Tables	110
	Wobble Stools	110
	Scatter Cushions	111
	Power Connections	112



Upholstery and Re-Upholstery Services

Upholstery and Re-Upholstery Services	114
---------------------------------------	-----

24/7, Bariatric, & Task Chairs

	Eon	119
	Excelsior	120
	Excelsior Wood	120
	Ashton	121
	Century	122

Multipurpose

	Bergen	127
	Mata	131
	Prima	136
	Prima Nest & Stack	138
	Renza	141

Industrial

	Saddle & Perch	147
	TechChair & TechStools	148
	PU TechChair & TechStools	151
	Static Safe TechChair & TechStools	152
	Static Safe & Sterile TechChair & Tech Stools	154
	Medical Grade Clean Room TechChairs	157

Beams

	Mata Beam	161
	Prima Beam	163
	Tala	171

Office, Task & Guest Chair Mechanisms	174
---------------------------------------	-----

Chair Sizing Guide	175
--------------------	-----

Professional Memberships & Accreditations	176
---	-----

Fabric Advice	177
---------------	-----

Terms of Business	180
-------------------	-----

Delivery Map	182
--------------	-----



Soft Seating

As with all our soft seating, our modular units are designed and manufactured at our Oxfordshire factory using FSC® certified board and high density CMHR Crib 5 foams .

All our soft seating is designed and manufactured at our headquarters in Oxfordshire with the sustainability agenda always at the forefront of our design & manufacturing practices.

Our ranges include sofas and armchairs, together with families of modular, booth and banquette seating, designed for style and comfort and to provide a solution for every type of setting.

- Our cores are made from FSC® certified board which gives them strength and durability.
- All our soft seating uses high density CMHR Crib 5 foams.

We are happy to manufacture to your requirements where non-standard dimensions or bespoke solutions are needed. Just call us to discuss.









Please note: References to right arm, left arm, right corner or left corner are from a seated position.



Soft Seating Sofas, Armchairs & Lounge Chairs

rhbr has created a broad range of sofas, armchairs and lounge chairs to cater for a wide variety of uses and styles.



	Cantay - NEW	15
	Harlan	17
	Hoxton and Hoxton Lux	19
	Kendra and Kendra Lux	21
	Kira	23
	Marna	27
	Nara	29
	Nova	31
	Horizon	33
	Rama	33
	Varda & Varda Footstool	35







Cantay - NEW



Classic contemporary sofa with clean lines and offering superb comfort for everywhere from reception and breakout areas to executive offices.

Product Name	Product Code	Dimensions	Fabric Groups							
			0	1	2	3	4	5	6	7
 Armchair	CANTAY1	H670 W830 D690 SD550 SH450		1,048	1,120	1,239	1,356	1,519	1,700	1,945
 Two-seater sofa	CANTAY2	H670 W1400 D690 SD550 SH450		1,391	1,469	1,599	1,726	1,904	2,100	2,368
 Three-seater sofa	CANTAY3	H670 W1970 D690 SD550 SH450		1,786	1,881	2,040	2,196	2,413	2,654	2,982

If fabrics in two or more fabric groups are used on one product it will be priced in the highest group. For any patterned or velvet fabrics a surcharge will be added to cover the additional fabric usage.



Harlan



Stunning metal-frame lounge chair for any public areas where something of a statement is required.

Product Name	Product Code	Dimensions	Fabric Groups							
			0	1	2	3	4	5	6	7
 Harlan Lounge Chair	HARLAN	H930 W1000 D800 SH580 SD430		1,876	1,906	1,955	2,002	2,070	2,144	2,245







If fabrics in two or more fabric groups are used on one product it will be priced in the highest group. For any patterned or velvet fabrics a surcharge will be added to cover the additional fabric usage.



Hoxton and Hoxton Lux

Contemporary range, available with standard foams or with deep premium foams for high-end luxury and a focus on the ultimate in comfort.



Product Name	Product Code	Dimensions	Fabric Groups							
			0	1	2	3	4	5	6	7
 Armchair	HOXTON1	H880 W1000 D800 SD587 SH430		1,226	1,291	1,399	1,505	1,654	1,818	2,041
 Two-seater sofa	HOXTON2	H880 W1660 D800 SD587 SH430		1,783	1,880	2,041	2,199	2,420	2,665	2,997
 Three-seater sofa	HOXTON3	H880 W2300 D800 SD587 SH430		2,349	2,477	2,691	2,901	3,195	3,520	3,961
 Armchair - Lux Version	HOXTON1/ LUX	H880 W1000 D800 SD587 SH430		1,475	1,551	1,678	1,802	1,975	2,167	2,428
 Two-seater sofa - Lux Version	HOXTON2/ LUX	H880 W1660 D800 SD587 SH430		2,087	2,196	2,378	2,556	2,805	3,080	3,454
 Three-seater sofa - Lux version	HOXTON3/ LUX	H880 W2300 D800 SD587 SH430		2,759	2,903	3,144	3,380	3,710	4,076	4,572







If fabrics in two or more fabric groups are used on one product it will be priced in the highest group. For any patterned or velvet fabrics a surcharge will be added to cover the additional fabric usage.



Kendra and Kendra Lux



Stylish and superbly comfortable modern sofa available with standard foams or with deep premium quality foams for high-end luxury and a focus on the ultimate in comfort.

Product Name	Product Code	Dimensions	Fabric Groups							
			0	1	2	3	4	5	6	7
 Armchair	KENDRA/1	H740 W1130 D825 SD600 SH415		1,288	1,353	1,461	1,567	1,715	1,879	2,103
 Two-seater sofa	KENDRA/2	H740 W1730 D825 SD600 SH415		1,757	1,836	1,967	2,097	2,277	2,477	2,749
 Three-seater sofa	KENDRA/3	H740 W2330 D825 SD600 SH415		2,241	2,341	2,509	2,672	2,901	3,155	3,499
 Armchair - Lux Version	KENDRA/1/ LUX	H740 W1130 D825 SD600 SH415		1,459	1,532	1,654	1,773	1,940	2,125	2,376
 Two-seater sofa - Lux version	KENDRA/2/ LUX	H740 W1730 D825 SD600 SH415		2,019	2,108	2,256	2,401	2,605	2,829	3,135
 Three-seater sofa - Lux Version	KENDRA/3/ LUX	H740 W2330 D825 SD600 SH415		2,551	2,664	2,852	3,036	3,294	3,579	3,966

If fabrics in two or more fabric groups are used on one product it will be priced in the highest group. For any patterned or velvet fabrics a surcharge will be added to cover the additional fabric usage.



Kira



Stylish and versatile family of lounge seating with options from high back executive to compact and a wide variety of bases available in addition to the ones shown on these pages – please enquire.









	Product Name	Product Code	Dimensions	Fabric Groups							
				0	1	2	3	4	5	6	7
	Kira65 5-Star Polished Aluminium Base with Castors on Gas Lift	KIRA65/EXEC	H1300 W650 D550 SH450		932	962	1,013	1,063	1,133	1,210	1,314
	Kira65 Black 4-Star Fixed Base and Swivel Mech	KIRA65/LOUNGE	H1300 W650 D550 SH450		972	1,002	1,053	1,103	1,172	1,249	1,354
	Kira65 Ottoman Black 4-Star Fixed Base and Swivel Mech	KIRA65/OTTO	H1300 W650 D550 SH450		378	385	395	405	420	436	458
	Kira60 Flamingo Swivel Stork Black Nylon Base	KIRA60/FLAMINGO	H950 W600 D500 SH480		657	682	724	766	824	888	975
	Kira60 Flamingo Swivel Stork Black Nylon Base on Castors	KIRA60/FLAM/C	H950 W600 D500 SH480		658	683	726	767	825	890	977
	Kira60 Black Nylon 5-Star Base, Gas Lift, Soft Wheel Castors	KIRA60/OFFICE/B	H950 W600 D500 SH480		636	661	704	745	803	868	955
	Kira60 Wooden Swivel Stork Base	KIRA60/WOOD-STORK	H950 W600 D500 SH480		773	798	982	882	940	1,004	1,092
	Kira60 4-Star Aluminium Base, Gas Lift, Soft Wheel Castors	KIRA60/4STAR/ALU	H950 W600 D500 SH480		700	725	768	809	867	932	1,019

If fabrics in two or more fabric groups are used on one product it will be priced in the highest group. For any patterned or velvet fabrics a surcharge will be added to cover the additional fabric usage.



Kira



	Product Name	Product Code	Dimensions	Fabric Groups							
				0	1	2	3	4	5	6	7
	Kira58 Flamingo Swivel Stork Black Nylon Base	KIRA58/FLAMINGO	H950 W600 D500 SH480		577	594	622	648	686	728	785
	Kira58 Flamingo Swivel Stork Black Nylon Base on Castors	KIRA58/FLAM/C	H950 W600 D500 SH480		579	595	623	650	688	729	786
	Kira58 Wooden Swivel Stork Base	KIRA58/WOOD-STORK	H750 W560 D450 SH420		694	710	738	765	802	844	901
	Kira 58 4-Star Aluminium Fixed Base with Gas Lift	KIRA58/4STAR/ALU	H750 W560 D450 SH420		598	615	642	669	707	749	806
	Kira58 4-Star Aluminium Base, Gas Lift, Soft Wheel Castors	KIRA58/4STAR/ALUC	H750 W560 D450 SH420		621	638	665	692	730	771	828
	Kira56 Flamingo Swivel Stork Black Nylon Base	KIRA56/FLAMINGO	H750 W560 D450 SH420		524	538	661	584	616	651	699
	Kira56 Flamingo Swivel Stork Black Nylon Base on Castors	KIRA56/FLAM/C	H750 W550 D450 SH450		525	539	663	585	617	653	701
	Kira56 5-Star Black Nylon Base, Gas Lift, Castors	KIRA56/OF-FICE/B	H750 W550 D450 SH450		501	517	545	572	609	651	708
	Kira56 Wooden Swivel Stork Base	KIRA56/WOOD-STORK	H770 W550 D450 SH450		650	667	694	721	759	801	857







If fabrics in two or more fabric groups are used on one product it will be priced in the highest group. For any patterned or velvet fabrics a surcharge will be added to cover the additional fabric usage.

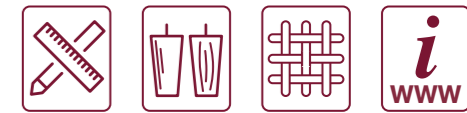

Marna

Contemporary armchair and sofa.



Product Name	Product Code	Dimensions	Fabric Groups							
			0	1	2	3	4	5	6	7
 Armchair	MARNA01	H650 W970 D850 SD610 SH420		969	1,027	1,123	1,218	1,350	1,496	1,695
 Two-Seater Sofa	MARNA02	H650 W1580 D850 SD610 SH420		1,292	1,367	1,491	1,613	1,785	1,974	2,231
 Three-Seater Sofa	MARNA03	H650 W2180 D850 SD610 SH420		1,615	1,708	1,864	2,016	2,229	2,464	2,784
 Armchair	MARNA01/ NF	H650 W970 D850 SD610 SH420		927	982	1,074	1,164	1,290	1,429	1,618
 Two-Seater Sofa	MARNA02/ NF	H650 W1580 D850 SD610 SH420		1,250	1,323	1,445	1,565	1,733	1,919	2,171
 Three-Seater Sofa	MARNA03/ NF	H650 W2180 D850 SD610 SH420		1,535	1,627	1,780	1,930	2,140	2,371	2,687



If fabrics in two or more fabric groups are used on one product it will be priced in the highest group. For any patterned or velvet fabrics a surcharge will be added to cover the additional fabric usage.

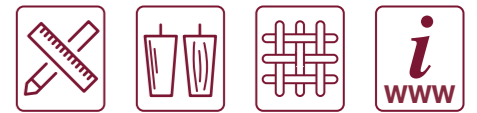

Nara

Smart occasional sofa.



Product Name	Product Code	Dimensions	Fabric Groups							
			0	1	2	3	4	5	6	7
 Armchair	NARA/1	H830 W805 D770 SD575 SH435		1,097	1,147	1,232	1,315	1,431	1,560	1,734
 Two-Seater Sofa	NARA/2	H830 W1410 D770 SD575 SH435		1,451	1,523	1,643	1,760	1,925	2,107	2,354
 Three-Seater Sofa	NARA/3	H830 W2015 D770 SD575 SH435		1,839	1,931	2,084	2,234	2,443	2,675	2,991



If fabrics in two or more fabric groups are used on one product it will be priced in the highest group. For any patterned or velvet fabrics a surcharge will be added to cover the additional fabric usage.



Nova



Classic tub chair and sofa.



Product Name	Product Code	Dimensions	Fabric Groups							
			0	1	2	3	4	5	6	7
 Nova Tub Chair	NOVA/1	H800 W680 D680 SD470 SH450		774	811	872	932	1,016	1,109	1,235
 Nova Double	NOVA/2	H800 W1360 D680 SD470 SH450		1,171	1,226	1,318	1,408	1,534	1,673	1,862

If fabrics in two or more fabric groups are used on one product it will be priced in the highest group. For any patterned or velvet fabrics a surcharge will be added to cover the additional fabric usage.

Horizon

Armchairs with solid natural beech frame for healthcare and other contract requirements.





Product Name	Product Code	Dimensions	Fabric Groups							
			0	1	2	3	4	5	6	7
 Chair with Arms	HORIZON/1/A	H800 W580 D650 SH450	574	614	634	669	703	751	803	875
 High Back Chair with Arms	HORIZON1/A/ HB	H1175 W640 D680 SH490	567	601	620	651	681	723	770	833
High Back Chair with Arms on wheels	HORIZON1/A/ HB/W	H1225 W640 D680 SH490	585	620	639	670	700	742	789	852

If fabrics in two or more fabric groups are used on one product it will be priced in the highest group. For any patterned or velvet fabrics a surcharge will be added to cover the additional fabric usage.

Rama

A version of our popular Nova tub range specifically designed for the contract market.



Product Name	Product Code	Dimensions	Fabric Groups							
			0	1	2	3	4	5	6	7
 Rama Tub Chair	RAMA/1	H775 W720 D635 SH460 SD540	442	509	545	604	662	744	833	956
 Rama Tub Chair BATCHES OF TWO (in same fabric only)	RAMA/1.2	H775 W720 D635 SH460 SD540	416	478	511	566	620	696	779	893
 Rama Double	RAMA/2	H775 W1390 D635 SH460 SD540	799	919	982	1,088	1,192	1,337	1,498	1,716





If fabrics in two or more fabric groups are used on one product it will be priced in the highest group. For any patterned or velvet fabrics a surcharge will be added to cover the additional fabric usage.



Varda & Varda Footstool



By popular demand, a larger tub chair providing the ultimate in comfort, complete with foot stool.



Product Name	Product Code	Dimensions	Fabric Groups							
			0	1	2	3	4	5	6	7
 Varda tub chair with removable seat cushion	VARDA/1/CUSH	H810 W770 D730 SD500 SH450		860	901	969	1,035	1,128	1,231	1,371
 VardaTub Chair	VARDA/1	H810 W770 D730 SD500 SH450		845	887	958	1,027	1,124	1,231	1,376
 Varda stool with chrome feet	VARDA/STOOL/1CHR	H450 W600 D440 SH450		334	358	398	437	492	553	635
 Varda stool with bung feet	VARDA/STOOL/1	H450 W600 D440 SH450		321	345	385	424	479	539	622
 Varda stool - set of 3 (each)	VARDA/STOOL/3	H450 W600 D440 SH450		283	296	317	338	367	399	442

If fabrics in two or more fabric groups are used on one product it will be priced in the highest group. For any patterned or velvet fabrics a surcharge will be added to cover the additional fabric usage.

Soft Seating Modular Seating

rhbr has a large range of modular seating units to permit multiple different configurations and enable the use of space to be maximized. Because we manufacture everything ourselves, we are also able to change the dimensions of any unit to fit either specific design requirements or room measurements.

 Bespoke Sizes Available	 Metal or Wood Legs	 Custom Fabrics Available	 Further product info
--	--	--	--

	Beanbag 2.0	39
	Kolbak	41
	Stella	45
	Zeta	48





Beanbag 2.0



An all-season classic re-invented in larger format to provide real comfort and support.

Product Name	Product Code	Dimensions	Fabric Groups							
			0	1	2	3	4	5	6	7
 Beanbag for adults	BEAN-BAG/2.0	DIA850		320	352	406	459	533	615	726







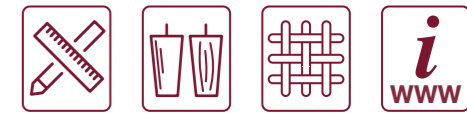

If fabrics in two or more fabric groups are used on one product it will be priced in the highest group. For any patterned or velvet fabrics a surcharge will be added to cover the additional fabric usage.



Kolbak Low



Fully modular seating system with straight and curved units in low, medium or high back, to accommodate a wide variety of uses and settings.

Product Name	Product Code	Dimensions	Fabric Groups							
			0	1	2	3	4	5	6	7
 Low Back Single	KOL/LB/S	H825 W570 D780 SD560 SH470		657	691	748	803	881	966	1,083
 Low Back Single Corner Left	KOL/LB/S/L	H825 W795 D780 SD560 SH470		974	1,028	1,117	1,205	1,327	1,463	1,647
 Low Back Single Corner Right	KOL/LB/S/R	H825 W795 D780 SD560 SH470		974	1,028	1,117	1,205	1,327	1,463	1,647
 Low Back Single Pod	KOL/LB/S/LR	H825 W1020 D780 SD560 SH470		1,157	1,227	1,342	1,455	1,613	1,788	2,026
 Low Back Double	KOL/LB/D	H825 W1110 D780 SD560 SH470		955	1,005	1,090	1,173	1,289	1,418	1,592
 Low Back Double Corner Right	KOL/LB/D/R	H825 W1335 D780 SD560 SH470		1,152	1,221	1,337	1,450	1,608	1,782	2,020
 Low Back Double Corner Left	KOL/LB/D/L	H825 W1335 D780 SD560 SH470		1,152	1,221	1,337	1,450	1,608	1,782	2,020
 Low Back Double Pod	KOL/LB/D/LR	H825 W1560 D780 SD560 SH470		1,294	1,368	1,490	1,610	1,778	1,963	2,215
Low Back Connecting Screen	KOL/LB/POD/PANEL	H825 W1000		455	475	508	540	585	635	703
 Low Back Round	KOL/LB/RND	H825 W1150 D840 SD560 SH470		988	1,041	1,131	1,218	1,341	1,477	1,661
Round Base Unit	KOL/RND	H470 W1230 D860		858	912	1,001	1,089	1,212	1,347	1,531

If fabrics in two or more fabric groups are used on one product it will be priced in the highest group. For any patterned or velvet fabrics a surcharge will be added to cover the additional fabric usage.

Kolbak Medium



Product Name	Product Code	Dimensions	Fabric Groups							
			0	1	2	3	4	5	6	7
Medium Back Single	KOL/MB/S	H1230 W570 D780 SD560 SH470		717	756	822	887	977	1,077	1,213
Medium Back Single Corner Right	KOL/MB/S/R	H1230 W795 D780 SD560 SH470		1,079	1,144	1,253	1,359	1,507	1,671	1,894
Medium Back Single Corner Left	KOL/MB/S/L	H1230 W795 D780 SD560 SH470		1,079	1,144	1,253	1,359	1,507	1,671	1,894
Medium Back Single Pod	KOL/MB/S/LR	H1230 W1000 D800 SD570 SH470		1,208	1,292	1,430	1,566	1,757	1,967	2,253
Medium Back Double	KOL/MB/D	H1230 W1110 D780 SD560 SH470		1,044	1,107	1,213	1,317	1,462	1,623	1,841
Medium Back Double Corner Right	KOL/MB/D/R	H1230 W1335 D780 SD560 SH470		1,316	1,387	1,505	1,620	1,781	1,959	2,202
Medium Back Double Corner Left	KOL/MB/D/L	H1230 W1335 D780 SD560 SH470		1,316	1,387	1,505	1,620	1,781	1,959	2,202
Medium Back Double Pod	KOL/MB/D/LR	H1230 W1560 D780 SD560 SH470		1,663	1,751	1,897	2,040	2,240	2,461	2,762
Medium Back Connecting Screen	KOL/MB/POD/PANEL	H1230 W1000		645	684	750	815	905	1,005	1,141
Medium Back Round	KOL/MB/RND	H1230 W1150 D840 SD560 SH470		1,301	1,376	1,500	1,623	1,794	1,983	2,240

If fabrics in two or more fabric groups are used on one product it will be priced in the highest group. For any patterned or velvet fabrics a surcharge will be added to cover the additional fabric usage.

Kolbak High



Product Name	Product Code	Dimensions	Fabric Groups							
			0	1	2	3	4	5	6	7
High Back Single Corner Right	KOL/HB/S/R	H1660 W795 D780 SD560 SH470		1,462	1,560	1,722	1,881	2,104	2,350	2,685
High Back Single Corner Left	KOL/HB/S/L	H1660 W795 D780 SD560 SH470		1,462	1,560	1,722	1,881	2,104	2,350	2,685
High Back Single Pod	KOL/HB/S/LR	H1660 W1020 D780 SD560 SH470		1,657	1,756	1,921	2,082	2,308	2,558	2,898
High Back Double Corner Right	KOL/HB/D/R	H1660 W1335 D780 SD560 SH470		1,770	1,876	2,052	2,225	2,467	2,735	3,099
High Back Double Corner Left	KOL/HB/D/L	H1660 W1335 D780 SD560 SH470		1,770	1,876	2,052	2,225	2,467	2,735	3,099
High Back Double Pod	KOL/HB/D/LR	H1660 W1560 D780 SD560 SH470		2,338	2,489	2,741	2,987	3,332	3,714	4,233
High Back Connecting Screen	KOL/HB/POD/PANEL	H1660 W1080		734	783	865	946	1,059	1,184	1,354
High Back Round	KOL/HB/RND	H1660 W1150 D840 SD560 SH470		1,388	1,476	1,622	1,764	1,964	2,186	2,486











If fabrics in two or more fabric groups are used on one product it will be priced in the highest group. For any patterned or velvet fabrics a surcharge will be added to cover the additional fabric usage.



Stella



Compact modular seating ideal for small and large projects with a huge variety of possible configurations.

Product Name	Product Code	Dimensions	Fabric Groups							
			0	1	2	3	4	5	6	7
 Single Curved Unit	ST2	H750 W790 D730 SD450 SH430		520	553	608	662	737	821	934
 1500 Curved Unit	ST4	H750 W1520 D720 SD450 SH430		980	1,034	1,123	1,210	1,332	1,467	1,650
 500 Unit	ST5	H750 W520 D720 SD450 SH430		483	513	561	609	676	750	850
 500 Unit on Castors	ST5/C	H750 W520 D720 SD450 SH430		485	514	563	610	677	751	851
 600 Plus Unit	ST6	H750 W620 D720 SD450 SH430		513	545	597	649	722	802	911
 600 Plus Unit on Castors	ST6/C	H750 W620 D720 SD450 SH430		516	548	601	652	725	805	914
 45 degree Angled Unit	ST7	H750 W710 D720 SD450 SH430		480	503	541	578	630	688	767
 90 degree Corner Unit	ST8	H750 W720 D720 SD450 SH430		742	784	854	922	1,018	1,124	1,268
 Corner Unit Plus	ST10	H750 W920 D920 SD450 SH430		894	953	1,050	1,145	1,279	1,427	1,628
 Curved Corner Unit	ST11	H750 W930 D720 SD450 SH430		526	562	621	679	761	851	973
 Double Unit Chair 1200	ST12	H750 W1200 D720 SD450 SH430		735	780	857	931	1,036	1,151	1,309

If fabrics in two or more fabric groups are used on one product it will be priced in the highest group. For any patterned or velvet fabrics a surcharge will be added to cover the additional fabric usage.

Zeta Standard Units

Fully modular seating for flexible configuration, with standard, curved and corner units. Ideal for small and large projects.

Please note: references to right arm, left arm, right corner or left corner are from a seated position.



Zeta Standard Units

Fully modular seating for flexible configuration, with standard, curved and corner units. Ideal for small and large projects.



Single ZETA1



Double ZETA2



Single back ZETA1/B



Double back ZETA2/2B



Right corner ZETA1/CO



Both corner ZETA2/LC/RC



Left corner ZETA2/B/LC



Right arm ZETA1/B/RA



Both arms ZETA1/B/RA/LA



Left arm ZETA2/2B/LA



ZETA2/POD

Zeta Standard Single Units

Fully modular seating for flexible configuration, with standard, curved and corner units. Ideal for small and large projects.



Product Name	Product Code	Dimensions	Fabric Groups							
			0	1	2	3	4	5	6	7
Single Unit	ZETA1	H425 W650 D650 SH425		323	337	360	383	415	450	498
Single Unit with Back	ZETA1/B	H775 W650 D650 SD485 SH425		442	464	500	535	584	639	713
Single Unit with Corner	ZETA1/CO	H775 W650 D650 SD485 SH425		491	517	559	601	659	723	810
Single Unit with Back and Left or Right Arm	ZETA1/B/LA or ZETA1/B/ RA	H775 W750 D650 SD485 SH425		581	613	666	718	790	871	980
Single Unit with Back and Left and Right Arms	ZETA1/B/LA/ RA	H775 W850 D650 SD485 SH425		733	775	845	913	1,009	1,115	1,259
Single Corner Unit	ZETA930C	H775 W930 D650 SH425		774	816	886	954	1,050	1,156	1,300

If fabrics in two or more fabric groups are used on one product it will be priced in the highest group. For any patterned or velvet fabrics a surcharge will be added to cover the additional fabric usage.

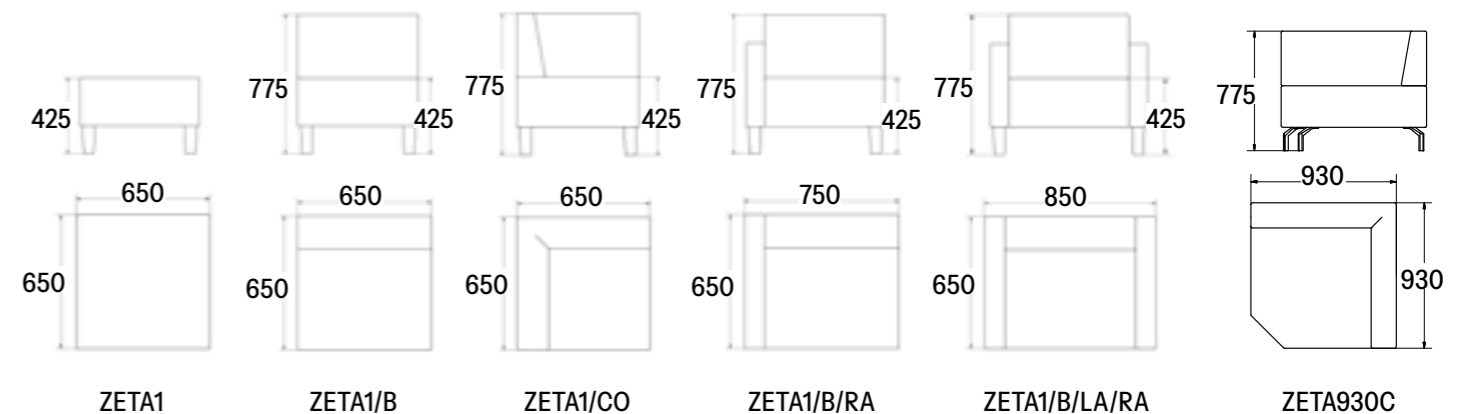

Zeta Standard Double Units



Fully modular seating for flexible configuration, with standard, curved and corner units. Ideal for small and large projects.

Product Name	Product Code	Dimensions	Fabric Groups							
			0	1	2	3	4	5	6	7
Double Unit	ZETA2	H425 W1300 D650 SH425		475	501	546	589	650	718	809
Double Unit with Single Back	ZETA2/1B	H775 W1300 D650 SD485 SH425		573	603	654	704	774	851	955
Double Unit with Double Back	ZETA2/2B	H775 W1300 D650 SD485 SH425		649	687	750	812	900	996	1,127
Double Unit with Left or Right Corner	ZETA2/LC or ZETA2/RC	H775 W1300 D650 SH425		738	774	833	891	972	1,062	1,185

If fabrics in two or more fabric groups are used on one product it will be priced in the highest group. For any patterned or velvet fabrics a surcharge will be added to cover the additional fabric usage.

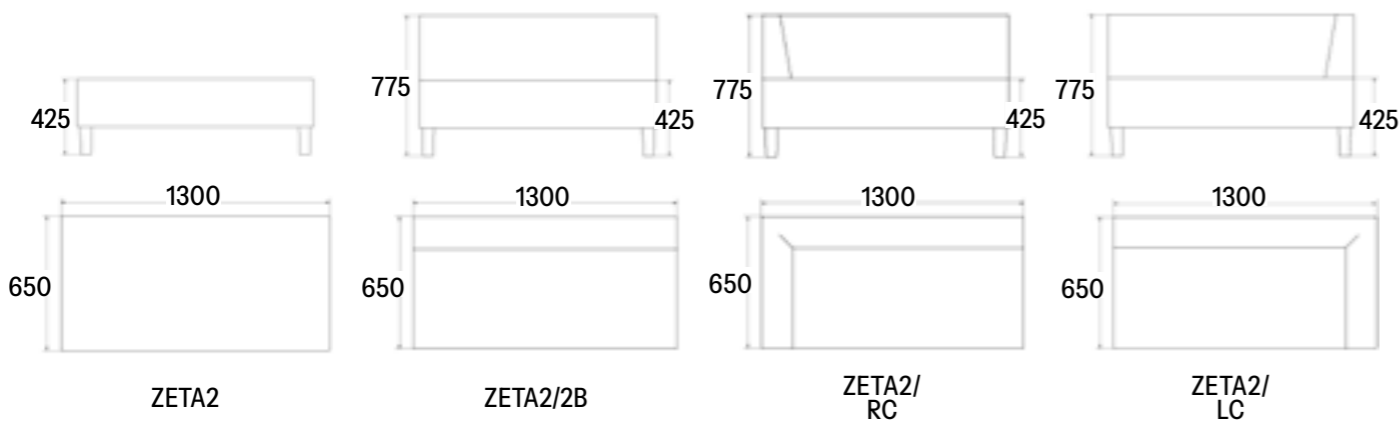

Zeta Standard Double Units



Fully modular seating for flexible configuration, with standard, curved and corner units. Ideal for small and large projects.

Product Name	Product Code	Dimensions	Fabric Groups							
			0	1	2	3	4	5	6	7
Double Unit with Back and Left or Right Corner	ZETA2/B/LC or ZETA2/B/ RC	H775 W1300 D650 SD485 SH425		792	835	907	977	1,076	1,185	1,334
Double Unit with Left and Right Corners	ZETA2/LC/ RC	H775 W1300 D650 SD485 SH425		872	925	1,014	1,101	1,223	1,358	1,541
Double Unit with Double Back and Left or Right Arm	ZETA2/2B/LA or ZETA2/2B/ RA	H775 W1400 D650 SD485 SH425		787	834	913	990	1,097	1,216	1,377
Double Unit with Double Back and Left and Right Arms	ZETA2/2B/ LA/RA	H775 W1500 D650 SD485 SH425		961	1,019	1,117	1,212	1,346	1,494	1,694
Double Pod	ZETA2/POD	H1340 W1360 D690 SD510 SH425		1,420	1,523	1,695	1,863	2,098	2,358	2,712

If fabrics in two or more fabric groups are used on one product it will be priced in the highest group. For any patterned or velvet fabrics a surcharge will be added to cover the additional fabric usage.

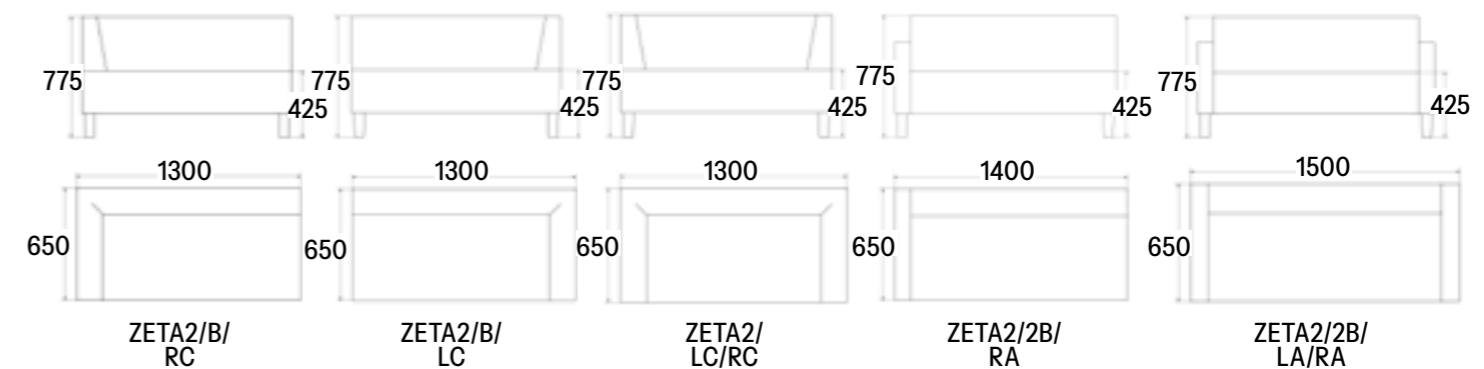



Zeta Curved and Corner Units



Fully modular seating for flexible configuration, with standard, curved and corner units.



45 Degree Curve
ZETAC45



90 Degree Curve
ZETAC90



Quarter Segment ZETAQ



Half Segment ZETAH



45 Degree Curve with Back
ZETAC45/B



90 Degree Curve with Back
ZETAC90/B



Half Segment with Back
ZETAH/B







90 Degree Curve with Inside
Back ZETA90/IB

Zeta Curved Units



Fully modular seating for flexible configuration, with standard, curved and corner units.

Product Name	Product Code	Dimensions	Fabric Groups							
			0	1	2	3	4	5	6	7
 45 Degree Curve	ZETAC45	H425 W950 D650 SH425		431	450	482	513	557	605	670
 45 Degree Curve with Back	ZETAC45/B	H775 W950 D650 SH425		599	628	677	725	791	865	966
 90 Degree Curve	ZETAC90	H425 W1625 D650 SH425		725	758	813	867	942	1,026	1,139
 90 Degree Curve with Back	ZETAC90/B	H775 W1625 D650 SH425		972	1,029	1,125	1,218	1,349	1,493	1,690
 90 Degree Curve with Inside Back	ZETA90/IB	H775 W1625 D650 SH425		880	927	1,005	1,082	1,190	1,308	1,470

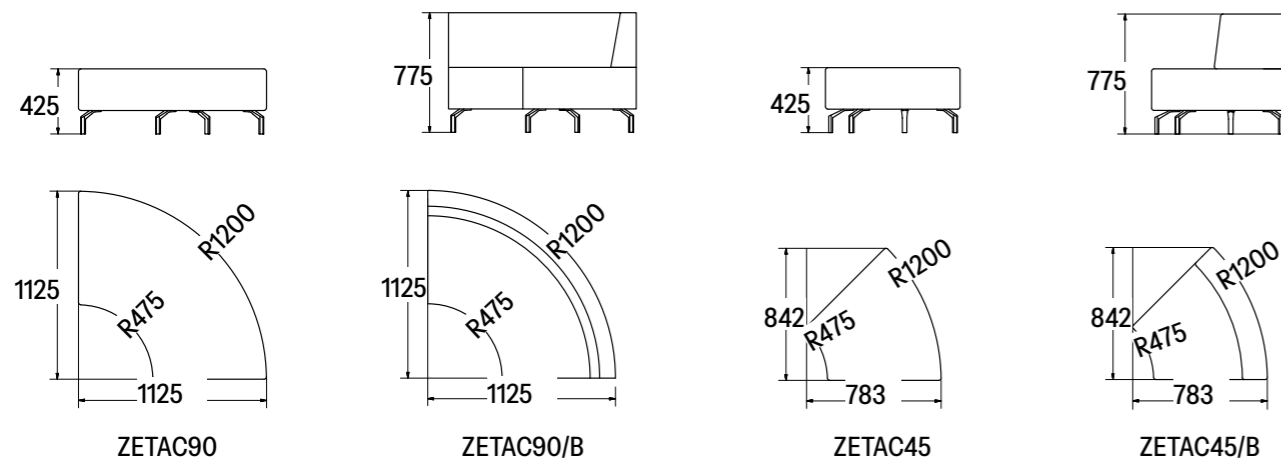

If fabrics in two or more fabric groups are used on one product it will be priced in the highest group. For any patterned or velvet fabrics a surcharge will be added to cover the additional fabric usage.



Zeta Curved Units



Fully modular seating for flexible configuration, with standard, curved and corner units.

Product Name	Product Code	Dimensions	Fabric Groups							
			0	1	2	3	4	5	6	7
 Quarter Segment	ZETAQ	H425 W650 D650 SH425		411	426	452	476	511	550	602
 Half Segment	ZETAH	H425 W1300 D650 SH425		589	617	663	709	773	843	939
 Half Segment with Back	ZETAH/B	H775 W1300 D650 SH425		741	775	832	888	967	1,053	1,171

If fabrics in two or more fabric groups are used on one product it will be priced in the highest group. For any patterned or velvet fabrics a surcharge will be added to cover the additional fabric usage.

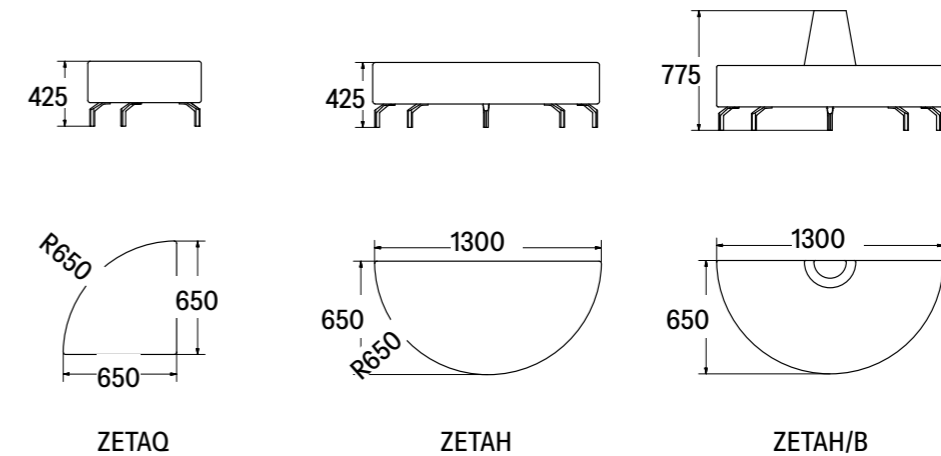

Soft Seating Banquette Seating

rhbr has created The Banq range to provide a wide variety of standard banquette seating options, combining single sided and back to back units with curves, planters and tables, to enable near limitless configurations for any space.

A choice of low, medium and high backs, two plinth heights or legs, and a selection of different stitching finishes, all combine to offer the flexibility to allow designs to be tailored to most project requirements.

However, if bespoke solutions are what is needed, our design team is here to work with you to translate your drawings into reality, whether that is through non-standard dimensions or a completely new design.

 Bespoke Sizes Available	 Metal or Wood Legs	 Legs or Plinths	 Custom Fabrics Available	 Further product info WWW
--	--	---	--	--

 The Banq - NEW 59







The Banq Low



The Banq is our most comprehensive and versatile range. As well as the choice of back heights and plinths or legs, all units can be upholstered with plain seat and back or with a quilted or a deep fluted stitching finish on either or both.











Product Name	Product Code	Dimensions	Fabric Groups							
			0	1	2	3	4	5	6	7
 Low Back Straight with 60mm plinth	BNQ/L/2/P60	H800 W1200 D750 SD550 SH470		1,131	1,192	1,296	1,397	1,538	1,695	1,908
 Low Back Corner with 60mm plinth	BNQ/L/CO/P60	H800 W750 D750 SD550 SH470		1,027	1,084	1,179	1,273	1,403	1,548	1,783
 Low Back Corner Double with 60mm plinth	BNQ/L/CO2/P60	H800 W1200 D750 SD550 SH470		1,272	1,340	1,454	1,566	1,722	1,894	2,164
 Low Back Back2Back with 60mm plinth	BNQ/L/B2B/P60	H800 W1200 D750 SD550 SH470		1,872	1,969	2,131	2,289	2,510	2,755	3,130
 Low Back 30 Degree Inner Curve with 60mm plinth	BNQ/L/30IC/P60	H800 W805 D750 SD550 SH470		869	910	979	1,047	1,141	1,245	1,447
 Low Back 45 Degree Inner Curve with 60mm plinth	BNQ/L/45IC/P60	H800 W1185 D750 SD550 SH470		1,062	1,119	1,215	1,308	1,439	1,583	1,805
 Low Back 30 Degree Outer Curve with 60mm plinth	BNQ/L/30OC/P60	H800 W805 D750 SD550 SH470		827	862	920	977	1,057	1,145	1,301
 Low Back 45 Degree Outer Curve with 60mm plinth	BNQ/L/45OC/P60	H800 W1185 D750 SD550 SH470		1,008	1,055	1,135	1,213	1,322	1,442	1,627
 Low Back Semi-Circle with 60mm plinth	BNQ/L/SEMIB/P60	H800 W1500 D760 SD550 SH470		1,233	1,277	1,351	1,424	1,526	1,638	1,820
 Low Back Quadrant with 60mm plinth	BNQ/L/QUADB/P60	H800 W1060 D760 SD550 SH470		761	791	841	891	960	1,036	1,167
 Low Planter	BNQ/L/PLNT	H800 W750 D350 SD550 SH470		552	583	636	688	761	841	969

If fabrics in two or more fabric groups are used on one product it will be priced in the highest group. For any patterned or velvet fabrics a surcharge will be added to cover the additional fabric usage.

The Banq Low



The Banq is our most comprehensive and versatile range. As well as the choice of back heights and plinths or legs, all units can be upholstered with plain seat and back or with a quilted or a deep fluted stitching finish on either or both.











Product Name	Product Code	Dimensions	Fabric Groups							
			0	1	2	3	4	5	6	7
 Low Back Straight with 150mm plinth	BNQ/L/2/P150	H800 W1200 D750 SD550 SH470		1,129	1,183	1,273	1,361	1,485	1,621	1,807
 Low Back Corner with 150mm plinth	BNQ/L/CO/P150	H800 W750 D750 SD550 SH470		1,026	1,078	1,165	1,251	1,371	1,503	1,717
 Low Back Corner Double with 150mm plinth	BNQ/L/CO2/P150	H800 W1200 D750 SD550 SH470		1,274	1,336	1,439	1,540	1,682	1,839	2,084
 Low Back Back2Back with 150mm plinth	BNQ/L/B2B/P150	H800 W1200 D750 SD550 SH470		1,850	1,936	2,079	2,219	2,415	2,631	2,965
 Low Back 30 Degree Inner Curve with 150mm plinth	BNQ/L/30IC/P150	H800 W805 D750 SD550 SH470		904	944	1,010	1,075	1,166	1,266	1,456
 Low Back 45 Degree Inner Curve with 150mm plinth	BNQ/L/45IC/P150	H800 W1185 D750 SD550 SH470		1,068	1,121	1,208	1,294	1,414	1,546	1,751
 Low Back 30 Degree Outer Curve with 150mm plinth	BNQ/L/30OC/P150	H800 W805 D750 SD550 SH470		830	860	911	960	1,029	1,105	1,241
 Low Back 45 Degree Outer Curve with 150mm plinth	BNQ/L/45OC/P150	H800 W1185 D750 SD550 SH470		1,009	1,052	1,124	1,194	1,292	1,400	1,566
 Low Back Semi-Circle with 150mm plinth	BNQ/L/SEMIB/P150	H800 W1500 D760 SD550 SH470		1,239	1,281	1,353	1,423	1,521	1,629	1,803
 Low Back Quadrant with 150mm plinth	BNQ/L/QUADB/P150	H800 W1060 D760 SD550 SH470		789	816	861	905	967	1,035	1,154

If fabrics in two or more fabric groups are used on one product it will be priced in the highest group. For any patterned or velvet fabrics a surcharge will be added to cover the additional fabric usage.

The Banq Low



The Banq is our most comprehensive and versatile range. As well as the choice of back heights and plinths or legs, all units can be upholstered with plain seat and back or with a quilted or a deep fluted stitching finish on either or both.

Product Name	Product Code	Dimensions	Fabric Groups							
			0	1	2	3	4	5	6	7
 Low Back Straight with 150mm metal legs	BNQ/L/2/L	H800 W1200 D750 SD550 SH470		1,087	1,141	1,231	1,319	1,443	1,579	1,765
 Low Back Corner with 150mm metal legs	BNQ/L/CO/L	H800 W750 D750 SD550 SH470		1,005	1,057	1,144	1,230	1,350	1,482	1,662
 Low Back Corner Double with 150mm metal legs	BNQ/L/CO2/L	H800 W1200 D750 SD550 SH470		1,243	1,305	1,408	1,510	1,651	1,808	2,020
 Low Back Back2Back with 150mm metal legs	BNQ/L/B2B/L	H800 W1200 D750 SD550 SH470		1,831	1,917	2,060	2,200	2,396	2,613	2,908
 Low Back 30 Degree Inner Curve with 150mm metal legs	BNQ/L/30IC/L	H800 W805 D750 SD550 SH470		876	916	982	1,047	1,138	1,238	1,374
 Low Back 45 Degree Inner Curve with 150mm metal legs	BNQ/L/45IC/L	H800 W1185 D750 SD550 SH470		1,047	1,100	1,187	1,273	1,393	1,525	1,705
 Low Back 30 Degree Outer Curve with 150mm metal legs	BNQ/L/30OC/L	H800 W805 D750 SD550 SH470		823	853	904	953	1,022	1,098	1,202
 Low Back 45 Degree Outer Curve with 150mm metal legs	BNQ/L/45OC/L	H800 W1185 D750 SD550 SH470		995	1,038	1,110	1,180	1,278	1,386	1,534
 Low Back Semi-Circle with 150mm metal legs	BNQ/L/SEMIB/L	H800 W1500 D760 SD550 SH470		1,176	1,218	1,290	1,360	1,458	1,566	1,714
 Low Back Quadrant with 150mm metal legs	BNQ/L/QUADB/L	H800 W1060 D760 SD550 SH470		768	795	840	884	946	1,014	1,107

If fabrics in two or more fabric groups are used on one product it will be priced in the highest group. For any patterned or velvet fabrics a surcharge will be added to cover the additional fabric usage.



The Banq Medium



The Banq is our most comprehensive and versatile range. As well as the choice of back heights and plinths or legs, all units can be upholstered with plain seat and back or with a quilted or a deep fluted stitching finish on either or both.











Product Name	Product Code	Dimensions	Fabric Groups							
			0	1	2	3	4	5	6	7
 Medium Back Straight with 60mm plinth	BNQ/M/2/P60	H1000 W1200 D750 SD550 SH470		1,197	1,265	1,379	1,490	1,646	1,819	2,054
 Medium Back Corner with 60mm plinth	BNQ/M/CO/P60	H1000 W750 D750 SD550 SH470		1,119	1,186	1,297	1,406	1,559	1,727	1,956
 Medium Back Corner Double with 60mm plinth	BNQ/M/CO2/P60	H1000 W1200 D750 SD550 SH470		1,381	1,459	1,589	1,716	1,894	2,090	2,358
 Medium Back Back2Back with 60mm plinth	BNQ/M/B2B/P60	H1000 W1200 D750 SD550 SH470		1,750	1,797	1,877	1,955	2,064	2,184	3,173
 Medium Back 30 Degree Inner Curve with 60mm plinth	BNQ/M/30IC/P60	H1000 W805 D750 SD550 SH470		1,011	1,075	1,181	1,284	1,430	1,590	1,579
 Medium Back 45 Degree Inner Curve with 60mm plinth	BNQ/M/45IC/P60	H1000 W1185 D750 SD550 SH470		1,044	1,084	1,150	1,215	1,305	1,406	1,886
 Medium Back 30 Degree Outer Curve with 60mm plinth	BNQ/M/30OC/P60	H1000 W805 D750 SD550 SH470		962	1,014	1,102	1,187	1,307	1,439	1,436
 Medium Back 45 Degree Outer Curve with 60mm plinth	BNQ/M/45OC/P60	H1000 W1185 D750 SD550 SH470		1,077	1,131	1,221	1,309	1,433	1,569	1,732
 Medium Back Semi-Circle with 60mm plinth	BNQ/M/SEMIB/P60	H1000 W1500 D760 SD550 SH470		1,290	1,344	1,434	1,522	1,645	1,782	1,967
 Medium Back Quadrant with 60mm plinth	BNQ/M/QUADB/P60	H1000 W1060 D760 SD550 SH470		804	839	898	955	1,035	1,123	1,243
 Medium Planter	BNQ/M/PLNT	H1000 W750 D350 SD550 SH470		590	628	691	753	841	937	1,068

If fabrics in two or more fabric groups are used on one product it will be priced in the highest group. For any patterned or velvet fabrics a surcharge will be added to cover the additional fabric usage.

The Banq Medium



The Banq is our most comprehensive and versatile range. As well as the choice of back heights and plinths or legs, all units can be upholstered with plain seat and back or with a quilted or a deep fluted stitching finish on either or both.











Product Name	Product Code	Dimensions	Fabric Groups							
			0	1	2	3	4	5	6	7
 Medium Back Straight with 150mm plinth	BNQ/M/2/P150	H1000 W1200 D750 SD550 SH470		1,191	1,252	1,352	1,451	1,589	1,741	1,949
 Medium Back Corner with 150mm plinth	BNQ/M/CO/P150	H1000 W750 D750 SD550 SH470		1,129	1,193	1,299	1,402	1,548	1,708	1,927
 Medium Back Corner Double with 150mm plinth	BNQ/M/CO2/P150	H1000 W1200 D750 SD550 SH470		1,395	1,467	1,586	1,703	1,866	2,047	2,292
 Medium Back Back2Back with 150mm plinth	BNQ/M/B2B/P150	H1000 W1200 D750 SD550 SH470		2,105	2,202	2,363	2,522	2,743	2,988	3,321
 Medium Back 30 Degree Inner Curve with 150mm plinth	BNQ/M/30IC/P150	H1000 W805 D750 SD550 SH470		965	1,010	1,084	1,156	1,258	1,370	1,523
 Medium Back 45 Degree Inner Curve with 150mm plinth	BNQ/M/45IC/P150	H1000 W1185 D750 SD550 SH470		1,120	1,178	1,276	1,372	1,507	1,655	1,857
 Medium Back 30 Degree Outer Curve with 150mm plinth	BNQ/M/30OC/P150	H1000 W805 D750 SD550 SH470		897	930	986	1,040	1,117	1,201	1,316
 Medium Back 45 Degree Outer Curve with 150mm plinth	BNQ/M/45OC/P150	H1000 W1185 D750 SD550 SH470		1,093	1,142	1,224	1,304	1,417	1,541	1,710
 Medium Back Semi-Circle with 150mm plinth	BNQ/M/SEMIB/P150	H1000 W1500 D760 SD550 SH470		1,244	1,287	1,359	1,429	1,527	1,635	1,783
 Medium Back Quadrant with 150mm plinth	BNQ/M/QUADB/P150	H1000 W1060 D760 SD550 SH470		806	836	887	936	1,005	1,081	1,185

If fabrics in two or more fabric groups are used on one product it will be priced in the highest group. For any patterned or velvet fabrics a surcharge will be added to cover the additional fabric usage.

The Banq Medium



The Banq is our most comprehensive and versatile range. As well as the choice of back heights and plinths or legs, all units can be upholstered with plain seat and back or with a quilted or a deep fluted stitching finish on either or both.

Product Name	Product Code	Dimensions	Fabric Groups							
			0	1	2	3	4	5	6	7
 Medium Back Straight with 150mm metal legs	BNQ/M/2/L	H1000 W1200 D750 SD550 SH470		1,155	1,215	1,316	1,414	1,552	1,704	1,912
 Medium Back Corner with 150mm metal legs	BNQ/M/CO/L	H1000 W750 D750 SD550 SH470		1,113	1,176	1,282	1,386	1,531	1,692	1,910
 Medium Back Corner Double with 150mm metal legs	BNQ/M/CO2/L	H1000 W1200 D750 SD550 SH470		1,370	1,442	1,561	1,678	1,841	2,022	2,267
 Medium Back Back2Back with 150mm metal legs	BNQ/M/B2B/L	H1000 W1200 D750 SD550 SH470		2,097	2,194	2,356	2,514	2,736	2,980	3,313
 Medium Back 30 Degree Inner Curve with 150mm metal legs	BNQ/M/30IC/L	H1000 W805 D750 SD550 SH470		948	993	1,067	1,140	1,241	1,354	1,506
 Medium Back 45 Degree Inner Curve with 150mm metal legs	BNQ/M/45IC/L	H1000 W1185 D750 SD550 SH470		1,104	1,162	1,260	1,356	1,491	1,639	1,841
 Medium Back 30 Degree Outer Curve with 150mm metal legs	BNQ/M/30OC/L	H1000 W805 D750 SD550 SH470		880	913	969	1,023	1,100	1,184	1,299
 Medium Back 45 Degree Outer Curve with 150mm metal legs	BNQ/M/45OC/L	H1000 W1185 D750 SD550 SH470		1,077	1,126	1,208	1,289	1,401	1,525	1,695
 Medium Back Semi-Circle with 150mm metal legs	BNQ/M/SEMIB/L	H1000 W1500 D760 SD550 SH470		1,181	1,224	1,296	1,366	1,464	1,572	1,719
 Medium Back Quadrant with 150mm metal legs	BNQ/M/QUADB/L	H1000 W1060 D760 SD550 SH470		792	822	873	922	991	1,067	1,171











If fabrics in two or more fabric groups are used on one product it will be priced in the highest group. For any patterned or velvet fabrics a surcharge will be added to cover the additional fabric usage.



The Banq High



The Banq is our most comprehensive and versatile range. As well as the choice of back heights and plinths or legs, all units can be upholstered with plain seat and back or with a quilted or a deep fluted stitching finish on either or both.

Product Name	Product Code	Dimensions	Fabric Groups							
			0	1	2	3	4	5	6	7
 High Back Straight with 60mm plinth	BNQ/H/2/P60	H1200 W1200 D750 SD550 SH470		1,286	1,364	1,494	1,621	1,799	1,996	2,263
 High Back Corner with 60mm plinth	BNQ/H/CO/P60	H1200 W750 D750 SD550 SH470		1,218	1,297	1,430	1,559	1,741	1,941	2,214
 High Back Corner Double with 60mm plinth	BNQ/H/CO2/P60	H1200 W1200 D750 SD550 SH470		1,544	1,635	1,786	1,934	2,141	2,369	2,681
 High Back Back2Back with 60mm plinth	BNQ/H/B2B/P60	H1200 W1200 D750 SD550 SH470		1,997	2,114	2,310	2,502	2,771	3,068	3,472
 High Back 30 Degree Inner Curve with 60mm plinth	BNQ/H/30IC/P60	H1200 W805 D750 SD550 SH470		994	1,048	1,138	1,226	1,349	1,486	1,671
 High Back 45 Degree Inner Curve with 60mm plinth	BNQ/H/45IC/P60	H1200 W1185 D750 SD550 SH470		1,193	1,265	1,384	1,501	1,664	1,844	2,090
 High Back 30 Degree Outer Curve with 60mm plinth	BNQ/H/30OC/P60	H1200 W805 D750 SD550 SH470		909	951	1,019	1,087	1,181	1,286	1,428
 High Back 45 Degree Outer Curve with 60mm plinth	BNQ/H/45OC/P60	H1200 W1185 D750 SD550 SH470		1,124	1,184	1,285	1,383	1,521	1,674	1,881
 High Back Semi-Circle with 60mm plinth	BNQ/H/SEMIB/P60	H1200 W1500 D760 SD550 SH470		1,355	1,414	1,512	1,607	1,742	1,890	2,092
 High Back Quadrant with 60mm plinth	BNQ/H/QUADB/P60	H1200 W1060 D760 SD550 SH470		852	890	954	1,016	1,103	1,199	1,330
 High Planter	BNQ/H/PLNT	H1200 W750 D350 SD550 SH470		642	686	761	833	935	1,047	1,200

If fabrics in two or more fabric groups are used on one product it will be priced in the highest group. For any patterned or velvet fabrics a surcharge will be added to cover the additional fabric usage.

The Banq High



The Banq is our most comprehensive and versatile range. As well as the choice of back heights and plinths or legs, all units can be upholstered with plain seat and back or with a quilted or a deep fluted stitching finish on either or both.

Product Name	Product Code	Dimensions	Fabric Groups							
			0	1	2	3	4	5	6	7
High Back Straight with 150mm plinth	BNQ/H/2/150	H1200 W1200 D750 SD550 SH470		1,308	1,381	1,502	1,622	1,789	1,973	2,224
High Back Corner with 150mm plinth	BNQ/H/CO/ P150	H1200 W750 D750 SD550 SH470		1,213	1,284	1,403	1,520	1,683	1,864	2,110
High Back Corner Double with 150mm plinth	BNQ/H/CO2/ P150	H1200 W1200 D750 SD550 SH470		1,524	1,608	1,748	1,886	2,078	2,291	2,580
High Back Back2Back with 150mm plinth	BNQ/H/B2B/ P150	H1200 W1200 D750 SD550 SH470		1,960	2,067	2,244	2,418	2,661	2,930	3,296
High Back 30 Degree Inner Curve with 150mm plinth	BNQ/H/30IC/ P150	H1200 W805 D750 SD550 SH470		989	1,036	1,116	1,194	1,302	1,423	1,587
High Back 45 Degree Inner Curve with 150mm plinth	BNQ/H/45IC/ P150	H1200 W1185 D750 SD550 SH470		1,199	1,264	1,372	1,479	1,628	1,792	2,016
High Back 30 Degree Outer Curve with 150mm plinth	BNQ/ H/30OC/ P150	H1200 W805 D750 SD550 SH470		882	919	979	1,039	1,123	1,215	1,340
High Back 45 Degree Outer Curve with 150mm plinth	BNQ/ H/45OC/ P150	H1200 W1185 D750 SD550 SH470		1,131	1,187	1,279	1,370	1,497	1,638	1,829
High Back Semi-Circle with 150mm plinth	BNQ/H/ SEMIB/P150	H1200 W1500 D760 SD550 SH470		1,361	1,420	1,518	1,614	1,748	1,897	2,099
High Back Quadrant with 150mm plinth	BNQ/H/ QUADB/P150	H1200 W1060 D760 SD550 SH470		865	900	958	1,015	1,095	1,183	1,303

If fabrics in two or more fabric groups are used on one product it will be priced in the highest group. For any patterned or velvet fabrics a surcharge will be added to cover the additional fabric usage.

The Banq High



The Banq is our most comprehensive and versatile range. As well as the choice of back heights and plinths or legs, all units can be upholstered with plain seat and back or with a quilted or a deep fluted stitching finish on either or both.

Product Name	Product Code	Dimensions	Fabric Groups							
			0	1	2	3	4	5	6	7
High Back Straight with 150mm metal legs	BNQ/H/2/L	H1200 W1200 D750 SD550 SH470		1,234	1,307	1,429	1,548	1,715	1,899	2,150
High Back Corner with 150mm metal legs	BNQ/H/CO/L	H1200 W750 D750 SD550 SH470		1,171	1,243	1,362	1,479	1,642	1,823	2,068
High Back Corner Double with 150mm metal legs	BNQ/H/ CO2/L	H1200 W1200 D750 SD550 SH470		1,472	1,556	1,697	1,834	2,027	2,239	2,529
High Back Back2Back with 150mm metal legs	BNQ/H/ B2B/L	H1200 W1200 D750 SD550 SH470		1,932	2,039	2,216	2,390	2,633	2,902	3,268
High Back 30 Degree Inner Curve with 150mm metal legs	BNQ/ H/30IC/L	H1200 W805 D750 SD550 SH470		966	1,013	1,093	1,170	1,279	1,400	1,563
High Back 45 Degree Inner Curve with 150mm metal legs	BNQ/ H/45IC/L	H1200 W1185 D750 SD550 SH470		1,169	1,234	1,342	1,449	1,597	1,762	1,986
High Back 30 Degree Outer Curve with 150mm metal legs	BNQ/ H/30OC/L	H1200 W805 D750 SD550 SH470		866	902	963	1,023	1,106	1,199	1,324
High Back 45 Degree Outer Curve with 150mm metal legs	BNQ/ H/45OC/L	H1200 W1185 D750 SD550 SH470		1,108	1,164	1,256	1,347	1,474	1,614	1,805
High Back Semi-Circle with 150mm metal legs	BNQ/H/ SEMIB/L	H1200 W1500 D760 SD550 SH470		1,278	1,337	1,435	1,531	1,665	1,813	2,015
High Back Quadrant with 150mm metal legs	BNQ/H/ QUADB/L	H1200 W1060 D760 SD550 SH470		842	877	935	992	1,072	1,160	1,280







If fabrics in two or more fabric groups are used on one product it will be priced in the highest group. For any patterned or velvet fabrics a surcharge will be added to cover the additional fabric usage.

The Banq Ends



The Banq is our most comprehensive and versatile range. As well as the choice of back heights and plinths or legs, all units can be upholstered with plain seat and back or with a quilted or a deep fluted stitching finish on either or both.



Product Name	Product Code	Dimensions	Fabric Groups							
			0	1	2	3	4	5	6	7
 Semi-Circle End	BNQ/SEMI/P60	H470 W1500 D760 SD760 SH470		1,202	1,247	1,321	1,394	1,495	1,608	1,760
 Semi-Circle End	BNQ/SEMI/P150	H470 W1500 D760 SD760 SH470		1,182	1,227	1,301	1,373	1,475	1,587	1,740
 Semi-Circle End	BNQ/SEMI/L	H470 W1500 D760 SD760 SH470		1,087	1,132	1,206	1,278	1,380	1,492	1,645
 Quadrant End	BNQ/QUAD/P60	H470 W1061 D762 SD762 SH470		771	801	852	901	970	1,046	1,150
 Quadrant End	BNQ/QUAD/P150	H470 W1061 D762 SD762 SH470		772	798	840	881	939	1,004	1,091
 Quadrant End	BNQ/QUAD/L	H470 W1061 D762 SD762 SH470		719	745	787	829	887	951	1,038
 Table Square no plinth	BNQ/T/SQ	H460 W750 D750		664	693	741	787	853	925	1,023





If fabrics in two or more fabric groups are used on one product it will be priced in the highest group. For any patterned or velvet fabrics a surcharge will be added to cover the additional fabric usage.



The Banq Lux Low



The Banq is our most comprehensive and versatile range. As well as the choice of back heights and plinths or legs, all units can be upholstered with plain seat and back or with a quilted or a deep fluted stitching finish on either or both.











Product Name	Product Code	Dimensions	Fabric Groups							
			0	1	2	3	4	5	6	7
 Low Back Straight with 60mm plinth	BQLUX/L/2/P60	H800 W1200 D750 SD550 SH470		1,213	1,275	1,378	1,479	1,621	1,777	1,990
 Low Back Corner with 60mm plinth	BQLUX/L/CO/P60	H800 W750 D750 SD550 SH470		1,112	1,169	1,265	1,358	1,489	1,633	1,868
 Low Back Corner Double with 60mm plinth	BQLUX/L/CO2/P60	H800 W1200 D750 SD550 SH470		1,386	1,455	1,569	1,680	1,836	2,009	2,279
 Low Back Back2Back with 60mm plinth	BQLUX/L/B2B/P60	H800 W1200 D750 SD550 SH470		2,000	2,097	2,259	2,417	2,638	2,883	3,258
 Low Back 30 Degree Inner Curve with 60mm plinth	BQLUX/L/30IC/P60	H800 W805 D750 SD550 SH470		932	974	1,043	1,110	1,204	1,309	1,511
 Low Back 45 Degree Inner Curve with 60mm plinth	BQLUX/L/45IC/P60	H800 W1185 D750 SD550 SH470		1,133	1,190	1,285	1,378	1,509	1,654	1,876
 Low Back 30 Degree Outer Curve with 60mm plinth	BQLUX/L/30OC/P60	H800 W805 D750 SD550 SH470		903	938	996	1,053	1,133	1,221	1,377
 Low Back 45 Degree Outer Curve with 60mm plinth	BQLUX/L/45OC/P60	H800 W1185 D750 SD550 SH470		1,073	1,121	1,200	1,278	1,387	1,507	1,693
 Low Back Semi-Circle with 60mm plinth	BQLUX/L/SEMIB/P60	H800 W1500 D760 SD550 SH470		1,343	1,388	1,462	1,534	1,636	1,748	1,931
 Low Back Quadrant with 60mm plinth	BQLUX/L/QUADB/P60	H800 W1060 D760 SD550 SH470		834	864	914	963	1,032	1,109	1,240
 Low Planter	BNQ/L/PLNT	H800 W750 D350 SD550 SH470		552	583	636	688	761	841	969

If fabrics in two or more fabric groups are used on one product it will be priced in the highest group. For any patterned or velvet fabrics a surcharge will be added to cover the additional fabric usage.

The Banq Lux Low



The Banq is our most comprehensive and versatile range. As well as the choice of back heights and plinths or legs, all units can be upholstered with plain seat and back or with a quilted or a deep fluted stitching finish on either or both.

Product Name	Product Code	Dimensions	Fabric Groups							
			0	1	2	3	4	5	6	7
 Low Back Straight with 150mm plinth	BQLUX/L/2/P150	H800 W1200 D750 SD550 SH470		1,248	1,302	1,392	1,480	1,604	1,740	1,926
 Low Back Corner with 150mm plinth	BQLUX/L/CO/P150	H800 W750 D750 SD550 SH470		1,115	1,168	1,255	1,341	1,460	1,593	1,806
 Low Back Corner Double with 150mm plinth	BQLUX/L/CO2/P150	H800 W1200 D750 SD550 SH470		1,361	1,423	1,526	1,628	1,769	1,926	2,171
 Low Back Back2Back with 150mm plinth	BQLUX/L/B2B/P150	H800 W1200 D750 SD550 SH470		1,983	2,069	2,212	2,352	2,548	2,765	3,098
 Low Back 30 Degree Inner Curve with 150mm plinth	BQLUX/L/30IC/P150	H800 W805 D750 SD550 SH470		986	1,026	1,092	1,157	1,248	1,348	1,538
 Low Back 45 Degree Inner Curve with 150mm plinth	BQLUX/L/45IC/P150	H800 W1185 D750 SD550 SH470		1,137	1,190	1,277	1,363	1,482	1,615	1,819
 Low Back 30 Degree Outer Curve with 150mm plinth	BQLUX/L/30OC/P150	H800 W805 D750 SD550 SH470		950	980	1,031	1,080	1,149	1,225	1,361
 Low Back 45 Degree Outer Curve with 150mm plinth	BQLUX/L/45OC/P150	H800 W1185 D750 SD550 SH470		1,081	1,124	1,196	1,266	1,364	1,472	1,638
 Low Back Semi-Circle with 150mm plinth	BQLUX/L/SEMIB/P150	H800 W1500 D760 SD550 SH470		1,328	1,370	1,442	1,512	1,610	1,718	1,892
 Low Back Quadrant with 150mm plinth	BQLUX/L/QUADB/P150	H800 W1060 D760 SD550 SH470		851	878	923	967	1,028	1,097	1,216











Stain repellent treatment (for fabric upholstered chairs) £2 per linear metre.

If fabrics in two or more different groups are used on one product it will be priced in the highest group. For any patterned or velvet fabrics a 10% surcharge is applied.

The Banq Lux Low



The Banq is our most comprehensive and versatile range. As well as the choice of back heights and plinths or legs, all units can be upholstered with plain seat and back or with a quilted or a deep fluted stitching finish on either or both.

Product Name	Product Code	Dimensions	Fabric Groups							
			0	1	2	3	4	5	6	7
 Low Back Straight with 150mm metal legs	BQLUX/L/2/L	H800 W1200 D750 SD550 SH470		1,206	1,260	1,350	1,438	1,562	1,698	1,884
 Low Back Corner with 150mm metal legs	BQLUX/L/CO/L	H800 W750 D750 SD550 SH470		1,094	1,147	1,234	1,320	1,439	1,572	1,785
 Low Back Corner Double with 150mm metal legs	BQLUX/L/CO2/L	H800 W1200 D750 SD550 SH470		1,330	1,392	1,495	1,597	1,738	1,895	2,140
 Low Back Back2Back with 150mm metal legs	BQLUX/L/B2B/L	H800 W1200 D750 SD550 SH470		1,965	2,050	2,193	2,333	2,529	2,746	3,079
 Low Back 30 Degree Inner Curve with 150mm metal legs	BQLUX/L/30IC/L	H800 W805 D750 SD550 SH470		965	1,005	1,071	1,136	1,227	1,327	1,517
 Low Back 45 Degree Inner Curve with 150mm metal legs	BQLUX/L/45IC/L	H800 W1185 D750 SD550 SH470		1,116	1,169	1,256	1,341	1,461	1,594	1,798
 Low Back 30 Degree Outer Curve with 150mm metal legs	BQLUX/L/30OC/L	H800 W805 D750 SD550 SH470		929	959	1,010	1,059	1,128	1,204	1,340
 Low Back 45 Degree Outer Curve with 150mm metal legs	BQLUX/L/45OC/L	H800 W1185 D750 SD550 SH470		1,060	1,103	1,175	1,245	1,343	1,451	1,617
 Low Back Semi-Circle with 150mm metal legs	BQLUX/L/SEMIB/L	H800 W1500 D760 SD550 SH470		1,265	1,307	1,379	1,449	1,547	1,655	1,829
 Low Back Quadrant with 150mm metal legs	BQLUX/L/QUADB/L	H800 W1060 D760 SD550 SH470		830	857	902	946	1,007	1,076	1,195





If fabrics in two or more fabric groups are used on one product it will be priced in the highest group. For any patterned or velvet fabrics a surcharge will be added to cover the additional fabric usage.



The Banq Lux Medium



The Banq is our most comprehensive and versatile range. As well as the choice of back heights and plinths or legs, all units can be upholstered with plain seat and back or with a quilted or a deep fluted stitching finish on either or both.

Product Name	Product Code	Dimensions	Fabric Groups							
			0	1	2	3	4	5	6	7
 Medium Back Straight with 60mm plinth	BQLUX/M/2/P60	H1000 W1200 D750 SD550 SH470		1,282	1,351	1,465	1,576	1,732	1,905	2,139
 Medium Back Corner with 60mm plinth	BQLUX/M/CO/P60	H1000 W750 D750 SD550 SH470		1,210	1,276	1,388	1,497	1,649	1,818	2,089
 Medium Back Corner Double with 60mm plinth	BQLUX/M/CO2/P60	H1000 W1200 D750 SD550 SH470		1,502	1,580	1,710	1,837	2,015	2,211	2,520
 Medium Back Back2Back with 60mm plinth	BQLUX/M/B2B/P60	H1000 W1200 D750 SD550 SH470		2,096	2,201	2,376	2,547	2,787	3,051	3,460
 Medium Back 30 Degree Inner Curve with 60mm plinth	BQLUX/M/30IC/P60	H1000 W805 D750 SD550 SH470		983	1,031	1,110	1,188	1,297	1,418	1,646
 Medium Back 45 Degree Inner Curve with 60mm plinth	BQLUX/M/45IC/P60	H1000 W1185 D750 SD550 SH470		1,158	1,221	1,327	1,431	1,576	1,737	1,985
 Medium Back 30 Degree Outer Curve with 60mm plinth	BQLUX/M/30OC/P60	H1000 W805 D750 SD550 SH470		1,002	1,042	1,108	1,173	1,264	1,364	1,540
 Medium Back 45 Degree Outer Curve with 60mm plinth	BQLUX/M/45OC/P60	H1000 W1185 D750 SD550 SH470		1,117	1,170	1,257	1,343	1,462	1,595	1,799
 Medium Back Semi-Circle with 60mm plinth	BQLUX/M/SEMIB/P60	H1000 W1500 D760 SD550 SH470		1,394	1,448	1,538	1,626	1,749	1,886	2,104
 Medium Back Quadrant with 60mm plinth	BQLUX/M/QUADB/P60	H1000 W1060 D760 SD550 SH470		873	908	966	1,023	1,103	1,191	1,345
 Medium Planter	BNQ/M/PLNT	H1000 W750 D350 SD550 SH470		590	628	691	753	841	937	1,068

If fabrics in two or more fabric groups are used on one product it will be priced in the highest group. For any patterned or velvet fabrics a surcharge will be added to cover the additional fabric usage.

The Banq Lux Medium

The Banq is our most comprehensive and versatile range. As well as the choice of back heights and plinths or legs, all units can be upholstered with plain seat and back or with a quilted or a deep fluted stitching finish on either or both.



Product Name	Product Code	Dimensions	Fabric Groups							
			0	1	2	3	4	5	6	7
Medium Back Straight with 150mm plinth	BQLUX/M/2/P150	H1000 W1200 D750 SD550 SH470		1,290	1,350	1,451	1,550	1,688	1,840	2,047
Medium Back Corner with 150mm plinth	BQLUX/M/CO/P150	H1000 W750 D750 SD550 SH470		1,213	1,277	1,383	1,487	1,632	1,792	2,048
Medium Back Corner Double with 150mm plinth	BQLUX/M/CO2/P150	H1000 W1200 D750 SD550 SH470		1,484	1,556	1,675	1,792	1,955	2,136	2,421
Medium Back Back2Back with 150mm plinth	BQLUX/M/B2B/P150	H1000 W1200 D750 SD550 SH470		2,104	2,201	2,362	2,520	2,742	2,986	3,364
Medium Back 30 Degree Inner Curve with 150mm plinth	BQLUX/M/30IC/P150	H1000 W805 D750 SD550 SH470		1,008	1,053	1,127	1,199	1,301	1,413	1,626
Medium Back 45 Degree Inner Curve with 150mm plinth	BQLUX/M/45IC/P150	H1000 W1185 D750 SD550 SH470		1,148	1,207	1,305	1,401	1,535	1,684	1,913
Medium Back 30 Degree Outer Curve with 150mm plinth	BQLUX/M/30OC/P150	H1000 W805 D750 SD550 SH470		947	980	1,036	1,090	1,166	1,251	1,402
Medium Back 45 Degree Outer Curve with 150mm plinth	BQLUX/M/45OC/P150	H1000 W1185 D750 SD550 SH470		1,135	1,185	1,267	1,347	1,460	1,584	1,774
Medium Back Semi-Circle with 150mm plinth	BQLUX/M/SEMIB/P150	H1000 W1500 D760 SD550 SH470		1,304	1,347	1,418	1,488	1,586	1,694	1,872
Medium Back Quadrant with 150mm plinth	BQLUX/M/QUADB/P150	H1000 W1060 D760 SD550 SH470		877	907	957	1,006	1,075	1,152	1,282

If fabrics in two or more fabric groups are used on one product it will be priced in the highest group. For any patterned or velvet fabrics a surcharge will be added to cover the additional fabric usage.

The Banq Lux Medium

The Banq is our most comprehensive and versatile range. As well as the choice of back heights and plinths or legs, all units can be upholstered with plain seat and back or with a quilted or a deep fluted stitching finish on either or both.

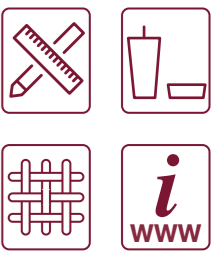

Product Name	Product Code	Dimensions	Fabric Groups							
			0	1	2	3	4	5	6	7
Medium Back Straight with 150mm metal legs	BQLUX/M/2/L	H1000 W1200 D750 SD550 SH470		1,248	1,308	1,409	1,508	1,646	1,798	2,005
Medium Back Corner with 150mm metal legs	BQLUX/M/CO/L	H1000 W750 D750 SD550 SH470		1,192	1,256	1,362	1,466	1,611	1,771	2,027
Medium Back Corner Double with 150mm metal legs	BQLUX/M/CO2/L	H1000 W1200 D750 SD550 SH470		1,453	1,525	1,644	1,761	1,924	2,105	2,390
Medium Back Back2Back with 150mm metal legs	BQLUX/M/B2B/L	H1000 W1200 D750 SD550 SH470		2,085	2,182	2,343	2,502	2,723	2,968	3,345
Medium Back 30 Degree Inner Curve with 150mm metal legs	BQLUX/M/30IC/L	H1000 W805 D750 SD550 SH470		987	1,032	1,106	1,178	1,280	1,392	1,605
Medium Back 45 Degree Inner Curve with 150mm metal legs	BQLUX/M/45IC/L	H1000 W1185 D750 SD550 SH470		1,127	1,186	1,284	1,380	1,514	1,663	1,892
Medium Back 30 Degree Outer Curve with 150mm metal legs	BQLUX/M/30OC/L	H1000 W805 D750 SD550 SH470		926	959	1,015	1,069	1,145	1,230	1,381
Medium Back 45 Degree Outer Curve with 150mm metal legs	BQLUX/M/45OC/L	H1000 W1185 D750 SD550 SH470		1,114	1,163	1,246	1,326	1,438	1,563	1,753
Medium Back Semi-Circle with 150mm metal legs	BQLUX/M/SEMIB/L	H1000 W1500 D760 SD550 SH470		1,241	1,283	1,355	1,425	1,523	1,631	1,809
Medium Back Quadrant with 150mm metal legs	BQLUX/M/QUADB/L	H1000 W1060 D760 SD550 SH470		856	886	936	985	1,054	1,131	1,261











If fabrics in two or more fabric groups are used on one product it will be priced in the highest group. For any patterned or velvet fabrics a surcharge will be added to cover the additional fabric usage.



The Banq Lux High

The Banq is our most comprehensive and versatile range. As well as the choice of back heights and plinths or legs, all units can be upholstered with plain seat and back or with a quilted or a deep fluted stitching finish on either or both.



Product Name	Product Code	Dimensions	Fabric Groups							
			0	1	2	3	4	5	6	7
 High Back Straight with 60mm plinth	BQLUX/H/2/P60	H1200 W1200 D750 SD550 SH470		1,362	1,440	1,569	1,696	1,874	2,071	2,338
 High Back Corner with 60mm plinth	BQLUX/H/CO/P60	H1200 W750 D750 SD550 SH470		1,321	1,400	1,532	1,662	1,844	2,044	2,365
 High Back Corner Double with 60mm plinth	BQLUX/H/CO2/P60	H1200 W1200 D750 SD550 SH470		1,630	1,721	1,872	2,019	2,226	2,455	2,815
 High Back Back2Back with 60mm plinth	BQLUX/H/B2B/P60	H1200 W1200 D750 SD550 SH470		2,165	2,283	2,479	2,671	2,939	3,236	3,696
 High Back 30 Degree Inner Curve with 60mm plinth	BQLUX/H/30IC/P60	H1200 W805 D750 SD550 SH470		1,032	1,086	1,176	1,264	1,388	1,524	1,782
 High Back 45 Degree Inner Curve with 60mm plinth	BQLUX/H/45IC/P60	H1200 W1185 D750 SD550 SH470		1,267	1,338	1,457	1,574	1,737	1,918	2,197
 High Back 30 Degree Outer Curve with 60mm plinth	BQLUX/H/30OC/P60	H1200 W805 D750 SD550 SH470		1,006	1,047	1,116	1,183	1,278	1,382	1,568
 High Back 45 Degree Outer Curve with 60mm plinth	BQLUX/H/45OC/P60	H1200 W1185 D750 SD550 SH470		1,193	1,254	1,354	1,453	1,591	1,743	1,976
 High Back Semi-Circle with 60mm plinth	BQLUX/H/SEMIB/P60	H1200 W1500 D760 SD550 SH470		1,449	1,507	1,605	1,701	1,836	1,984	2,223
 High Back Quadrant with 60mm plinth	BQLUX/H/QUADB/P60	H1200 W1060 D760 SD550 SH470		916	955	1,018	1,080	1,167	1,264	1,431
 High Planter	BNQ/H/PLNT	H1200 W750 D350 SD550 SH470		642	686	761	833	935	1,047	1,200

If fabrics in two or more fabric groups are used on one product it will be priced in the highest group. For any patterned or velvet fabrics a surcharge will be added to cover the additional fabric usage.

The Banq Lux High

The Banq is our most comprehensive and versatile range. As well as the choice of back heights and plinths or legs, all units can be upholstered with plain seat and back or with a quilted or a deep fluted stitching finish on either or both.



Product Name	Product Code	Dimensions	Fabric Groups							
			0	1	2	3	4	5	6	7
High Back Straight with 150mm plinth	BQLUX/H/2/150	H1200 W1200 D750 SD550 SH470		1,384	1,457	1,579	1,698	1,865	2,049	2,301
High Back Corner with 150mm plinth	BQLUX/H/CO/P150	H1200 W750 D750 SD550 SH470		1,303	1,374	1,493	1,610	1,773	1,954	2,245
High Back Corner Double with 150mm plinth	BQLUX/H/CO2/P150	H1200 W1200 D750 SD550 SH470		1,638	1,722	1,862	2,000	2,192	2,405	2,738
High Back Back2Back with 150mm plinth	BQLUX/H/B2B/P150	H1200 W1200 D750 SD550 SH470		2,149	2,256	2,433	2,607	2,850	3,119	3,537
High Back 30 Degree Inner Curve with 150mm plinth	BQLUX/H/30IC/P150	H1200 W805 D750 SD550 SH470		1,057	1,105	1,184	1,262	1,371	1,491	1,721
High Back 45 Degree Inner Curve with 150mm plinth	BQLUX/H/45IC/P150	H1200 W1185 D750 SD550 SH470		1,269	1,334	1,442	1,549	1,697	1,862	2,115
High Back 30 Degree Outer Curve with 150mm plinth	BQLUX/H/30OC/P150	H1200 W805 D750 SD550 SH470		1,004	1,040	1,101	1,161	1,244	1,337	1,503
High Back 45 Degree Outer Curve with 150mm plinth	BQLUX/H/45OC/P150	H1200 W1185 D750 SD550 SH470		1,201	1,257	1,350	1,440	1,567	1,708	1,922
High Back Semi-Circle with 150mm plinth	BQLUX/H/SEMIB/P150	H1200 W1500 D760 SD550 SH470		1,455	1,514	1,612	1,708	1,842	1,990	2,227
High Back Quadrant with 150mm plinth	BQLUX/H/QUADB/P150	H1200 W1060 D760 SD550 SH470		933	968	1,026	1,083	1,163	1,252	1,408

If fabrics in two or more fabric groups are used on one product it will be priced in the highest group. For any patterned or velvet fabrics a surcharge will be added to cover the additional fabric usage.

The Banq Lux High

The Banq is our most comprehensive and versatile range. As well as the choice of back heights and plinths or legs, all units can be upholstered with plain seat and back or with a quilted or a deep fluted stitching finish on either or both.



Product Name	Product Code	Dimensions	Fabric Groups							
			0	1	2	3	4	5	6	7
High Back Straight with 150mm metal legs	BQLUX/H/2/L	H1200 W1200 D750 SD550 SH470		1,310	1,383	1,505	1,624	1,791	1,976	2,227
High Back Corner with 150mm metal legs	BQLUX/H/CO/L	H1200 W750 D750 SD550 SH470		1,261	1,333	1,452	1,568	1,732	1,912	2,203
High Back Corner Double with 150mm metal legs	BQLUX/H/CO2/L	H1200 W1200 D750 SD550 SH470		1,586	1,671	1,811	1,948	2,141	2,353	2,687
High Back Back2Back with 150mm metal legs	BQLUX/H/B2B/L	H1200 W1200 D750 SD550 SH470		2,121	2,228	2,405	2,579	2,822	3,091	3,509
High Back 30 Degree Inner Curve with 150mm metal legs	BQLUX/H/30IC/L	H1200 W805 D750 SD550 SH470		1,027	1,075	1,154	1,232	1,341	1,461	1,691
High Back 45 Degree Inner Curve with 150mm metal legs	BQLUX/H/45IC/L	H1200 W1185 D750 SD550 SH470		1,239	1,304	1,412	1,519	1,667	1,832	2,085
High Back 30 Degree Outer Curve with 150mm metal legs	BQLUX/H/30OC/L	H1200 W805 D750 SD550 SH470		974	1,010	1,071	1,131	1,214	1,307	1,473
High Back 45 Degree Outer Curve with 150mm metal legs	BQLUX/H/45OC/L	H1200 W1185 D750 SD550 SH470		1,171	1,227	1,319	1,410	1,537	1,678	1,891
High Back Semi-Circle with 150mm metal legs	BQLUX/H/SEMIB/L	H1200 W1500 D760 SD550 SH470		1,371	1,430	1,528	1,624	1,758	1,907	2,143
High Back Quadrant with 150mm metal legs	BQLUX/H/QUADB/L	H1200 W1060 D760 SD550 SH470		903	938	996	1,053	1,133	1,221	1,378







If fabrics in two or more fabric groups are used on one product it will be priced in the highest group. For any patterned or velvet fabrics a surcharge will be added to cover the additional fabric usage.

The Banq Lux Ends



The Banq is our most comprehensive and versatile range. As well as the choice of back heights and plinths or legs, all units can be upholstered with plain seat and back or with a quilted or a deep fluted stitching finish on either or both.







Product Name	Product Code	Dimensions	Fabric Groups							
			0	1	2	3	4	5	6	7
 Semi-Circle End	BQLUX/ SEMI/P60	H470 W1500 D760 SD760 SH470		1,339	1,383	1,458	1,530	1,632	1,744	1,897
 Semi-Circle End	BQLUX/ SEMI/P150	H470 W1500 D760 SD760 SH470		1,305	1,349	1,423	1,496	1,597	1,710	1,890
 Semi-Circle End	BQLUX/ SEMI/L	H470 W1500 D760 SD760 SH470		1,172	1,217	1,291	1,364	1,465	1,578	1,758
 Quadrant End	BQLUX/ QUAD/P60	H470 W1061 D762 SD762 SH470		863	894	944	993	1,062	1,138	1,270
 Quadrant End	BQLUX/ QUAD/P150	H470 W1061 D762 SD762 SH470		842	867	910	951	1,009	1,073	1,180
 Quadrant End	BQLUX/ QUAD/L	H470 W1061 D762 SD762 SH470		787	813	855	897	955	1,019	1,122

If fabrics in two or more fabric groups are used on one product it will be priced in the highest group. For any patterned or velvet fabrics a surcharge will be added to cover the additional fabric usage.

Soft Seating Booth Seating

Booth Seating has become increasingly popular for all manner of settings and environments from waiting areas to restaurants, libraries to colleges and schools. Most important, these ranges can be made to your specific dimensions for height, depth and width.

-  Bespoke Sizes Available
-  Metal or Wood Legs
-  Custom Fabrics Available
-  Further product info

	Kolbak Booth	89
	Rondo Booth	91
	Zeta Booth	93

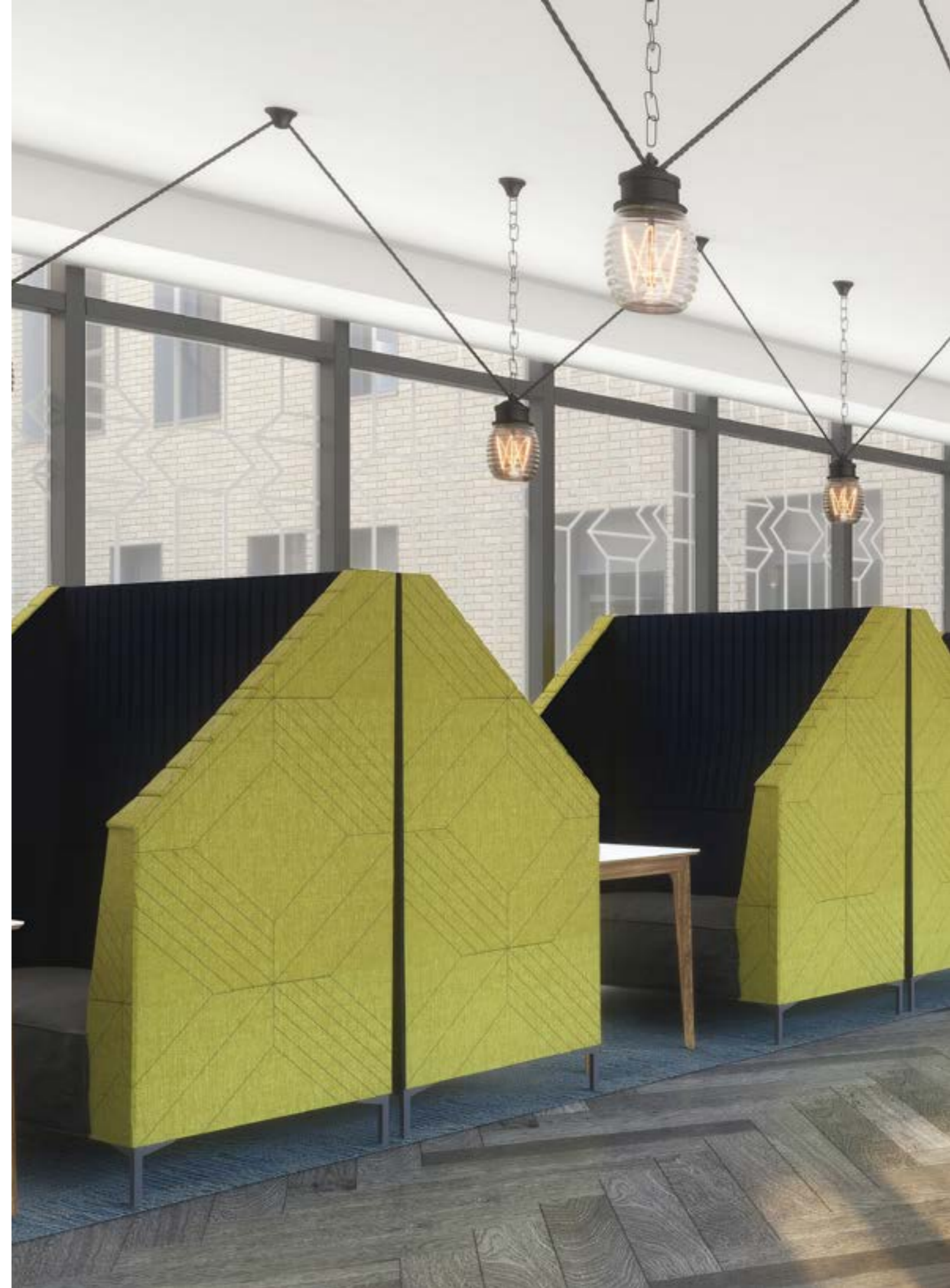

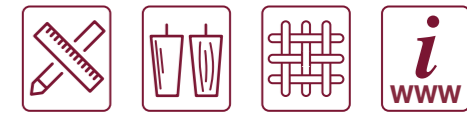

Kolbak Booth



The Kolbak Booth offers comfort and classic lines to provide the private spaces required for meetings or quiet working.



Product Name	Product Code	Dimensions	Fabric Groups							
			0	1	2	3	4	5	6	7
 Low Back Booth, table POA depending on finish	KOL/LB/BOOTH	H825 W2600 D1550 SD570 SH470		3,043	3,210	3,488	3,760	4,140	4,561	5,134
 Medium Back Booth, table POA depending on finish	KOL/MB/BOOTH	H1230 W2600 D1550 SD570 SH470		3,971	4,186	4,543	4,894	5,384	5,926	6,664
 High Back Booth, table POA depending on finish	KOL/HB/BOOTH	H1660 W2600 D1550 SD570 SH470		4,362	4,713	5,299	5,873	6,677	7,565	8,773

If fabrics in two or more fabric groups are used on one product it will be priced in the highest group. For any patterned or velvet fabrics a surcharge will be added to cover the additional fabric usage.



Rondo Booth



With soft rounded lines and seating with built-in webbing and layered upholstery, the Rondo Booth is a semi-private team space designed for up to four people. The back panel is AV ready and table top charging is available as standard

Product Name	Product Code	Dimensions	Fabric Groups						
			0	1	2	3	4	5	6
 Rondo Booth	RONDO/BOOTH		4,610	4,837	5,216	5,587	6,107	6,681	7,462

If fabrics in two or more fabric groups are used on one product it will be priced in the highest group. For any patterned or velvet fabrics a surcharge will be added to cover the additional fabric usage.

Zeta Booth



The shape of the Zeta Booth surround can be altered to suit the design requirements of any space. Just let us know what you are looking for in terms of aesthetic and we will work with you to create it



Product Name	Product Code	Dimensions	Fabric Groups							
			0	1	2	3	4	5	6	7
 Zeta Booth	ZETA/BOOTH	H1340 W2330 D1360		3,428	3,666	4,062	4,450	4,993	5,593	6,410

If fabrics in two or more fabric groups are used on one product it will be priced in the highest group. For any patterned or velvet fabrics a surcharge will be added to cover the additional fabric usage.

Soft Seating Stools

Stools provide the perfect solution to flexible seating requirements in all sorts of environments. Not only does rhbr have a wide variety of shapes and sizes available but many of them have polystyrene cores making them super-light and easy to move around.

 Bespoke Sizes Available	 Metal or Wood Legs	 Custom Fabrics Available	 Further product info
--	--	--	--

 Jupiter	97
 Valbo	99







Jupiter



Lightweight but robust round stool with polystyrene core and chrome legs.

Product Name	Product Code	Dimensions	Fabric Groups							
			0	1	2	3	4	5	6	7
 Jupiter Single Low Stool	JUP1	H460 W670 D470		327	341	363	385	415	449	494
 Jupiter Double Low Stool	JUP2	H460 W1115 D670		419	440	474	508	555	607	678





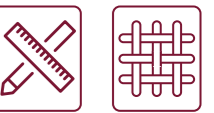



If fabrics in two or more fabric groups are used on one product it will be priced in the highest group. For any patterned or velvet fabrics a surcharge will be added to cover the additional fabric usage.

Valbo Polystyrene Cores



Lightweight range of stools, most with polystyrene cores making them extremely easy to move around as required.



Product Name	Product Code	Dimensions	Fabric Groups							
			0	1	2	3	4	5	6	7
 530 Round	VAL/530	H425 W650 D650 SH425		225	242	270	297	335	378	435
 530 Round 1Bite	VAL/530/1B	H425 W650 D650 SH425		227	243	271	298	337	379	436
 530 Round 2Bite	VAL/530/2B	H425 W650 D650 SH425		228	245	273	300	338	381	438
 Long	VAL/LONG	H425 W650 D650 SH425		356	379	418	456	510	569	649
 Long 1Bite	VAL/ LONG/1B	H425 W650 D650 SH425		354	377	416	455	508	567	648
 Long 2Bite	VAL/ LONG/2B	H425 W650 D650 SH425		353	376	415	453	507	566	646
 600 Hexagonal	VAL/600/ HEX	H450 W600 D600		233	251	281	310	351	396	457
 Square (Cross Elements)	VAL/SQ	H450 W450 D450		187	199	219	238	266	296	337







If fabrics in two or more fabric groups are used on one product it will be priced in the highest group. For any patterned or velvet fabrics a surcharge will be added to cover the additional fabric usage.



Valbo Timber Cores



These Valbo stools all have timber cores.

Product Name	Product Code	Dimensions	Fabric Groups							
			0	1	2	3	4	5	6	7
 900 Round	VAL/900	H425 W650 D650 SH425		393	418	461	503	561	626	714
 Large Ying	VAL/LGYING	H425 W650 D650 SH425		490	515	558	600	658	723	811
 Large Ying with Back	VAL/LGY- ING/450/B	H720 W1340 D880 SH450		697	737	804	869	961	1,062	1,200
 Angled Stool	VAL/ANG	H425 W650 D650 SH425		279	295	323	351	389	431	488
 Stool	VAL/STOOL	H425 W650 D650 SH425		271	287	315	343	381	423	481
 Cross	VALBO/ CROSS	H450 W1330 D1330		708	745	806	866	950	1,043	1,170

If fabrics in two or more fabric groups are used on one product it will be priced in the highest group. For any patterned or velvet fabrics a surcharge will be added to cover the additional fabric usage.

Soft Seating Seating for Kids

rhbr has fun, colourful ranges for all settings from libraries to classrooms.

 Bespoke Sizes Available	 Metal or Wood Legs	 Custom Fabrics Available	 Further product info
--	--	--	--

	Beanbag	104
	Dice/Cube	104
	Toadstool	105
	ZigZag	107



Beanbag

Versatile and comfortable, our beanbags are ideal for kids of all ages.





Product Name	Product Code	Dimensions	Fabric Groups									
			0	1	2	3	4	5	6	7		
 Beanbag	BEANBAG	DIA650	133	169	188	220	251	295	343	408		

If fabrics in two or more fabric groups are used on one product it will be priced in the highest group. For any patterned or velvet fabrics a surcharge will be added to cover the additional fabric usage.

Dice / Cube

Fun shaped stools to suit any education setting.





Product Name	Product Code	Dimensions	Fabric Groups									
			0	1	2	3	4	5	6	7		
 Dice	DICE	H400 W400	189	209	220	237	255	279	306	342		
 Cube	CUBE4	H400 W400	151	171	182	200	217	241	268	304		

If fabrics in two or more fabric groups are used on one product it will be priced in the highest group. For any patterned or velvet fabrics a surcharge will be added to cover the additional fabric usage.

Toadstool



Create an engaging learning environment for students with our fun and playful toadstools. Made with a lightweight polystyrene core making them robust and easy to move around.

Product Name	Product Code	Dimensions	Fabric Groups									
			0	1	2	3	4	5	6	7		
 Toadstool	TS1A	H410 W430	186	206	217	234	252	276	303	339		
 Toadstool in batches of 3	TS1B		472	500	514	539	563	597	635	686		

If fabrics in two or more fabric groups are used on one product it will be priced in the highest group. For any patterned or velvet fabrics a surcharge will be added to cover the additional fabric usage.











ZigZag



Extensive range of lightweight stools which can be configured to create endless layouts.



Product Name	Product Code	Dimensions	Fabric Groups							
			0	1	2	3	4	5	6	7
 430 Round	ZZ/430	H370 W430 D430	151	170	181	198	214	238	264	299
 430 Round 1 Bite	ZZ/430/1B	H370 W525 D520	149	169	179	196	213	236	262	297
 430 Round 2 Bite	ZZ/430/2B	H370 W525 D515	148	167	177	195	211	235	261	296
 Long	ZZ/LONG	H370 W1020 D430	233	258	271	293	315	345	379	425
 Long 1 Bite	ZZ/LONG/1B	H370 W960 D430	230	255	268	291	312	343	376	422
 Long 2 Bite	ZZ/LONG/2B	H370 W920 D430	227	252	265	288	309	340	373	419
 Angled Stool	ZZ/ANG	H370 W560 D550	210	229	239	256	273	296	322	357
 Stool	ZZ/STOOL	H370 W550 D500	189	208	218	235	252	275	301	336

If fabrics in two or more fabric groups are used on one product it will be priced in the highest group. For any patterned or velvet fabrics a surcharge will be added to cover the additional fabric usage.

Extras

We have a few items in the range that don't fit readily into any seating categories so we've grouped them in this Extras section.



Laptop Tables	110
Wobble Stools	110
Scatter Cushions	111
Power Connections	112



Laptop Tables

These make perfect tables for use in a variety of environments and not just for laptops either. We are seeing them in break-out and lounge areas, staff rooms and student social areas, reception – in fact pretty much anywhere where a small height-adjustable surface is needed.

Available with black or white top. Other finishes area available on request – please give us a call.



Product Name	Product Code	Dimensions	Std Prod Price	Fabric Groups								
				0	1	2	3	4	5	6	7	
 Laptop table	TAB/LAPTOP	H625-1050 W520 D380	330									

If fabrics in two or more fabric groups are used on one product it will be priced in the highest group. For any patterned or velvet fabrics a surcharge will be added to cover the additional fabric usage.

Wobble Stools

These height adjustable stools work anywhere from reception areas to offices, where the changes to working environments are seeing people sitting less but needing an occasional perch. The ball and socket mechanism at the base permits rotational movement which is a big plus for posture and general health.



Product Name	Product Code	Dimensions	Std Prod Price	Fabric Groups								
				0	1	2	3	4	5	6	7	
 Wobble stool	STOOL/ BALANCE	H590-850 W400 D400 SD300 SH590-850	393									

If fabrics in two or more fabric groups are used on one product it will be priced in the highest group. For any patterned or velvet fabrics a surcharge will be added to cover the additional fabric usage.









Scatter Cushions



The right selection of scatter cushions can make all the difference. They add an extra layer of colour, pattern, texture and personality to any individual piece of furniture or a curated space.

We make a wide variety of scatter cushions to complement any of our seating ranges or just to buy on their own. Our standard sizes are shown below and all are fibre-filled. Other sizes and feather/ down or wool fillings are available on request.

There is a discount on batch orders in the same fabric.

Product Name	Product Code	Dimensions	Fabric Groups							
			0	1	2	3	4	5	6	7
 Scatter Cushion 350mm x 350mm	CUSHION/ 350/1	W350 D350	52	61	65	73	80	91	103	119
 Scatter Cushion 350mm x 350mm (batches of 3 in the same fabric)	CUSHION/ 350/3	W350 D350	124	141	150	166	181	202	225	257
 Scatter Cushion 350mm x 500mm	CUSHION/ 300x500	W350 D500	57	70	77	89	100	116	133	157
 Scatter Cushion 350mm x 500mm (batches of 2 in the same fabric)	CUSHION/ 300x500.2	W350 D500	100	113	120	132	143	159	176	200
 Scatter Cushion 400mm x 400mm	CUSH- ION/400/1	W400 D400	54	65	71	81	90	103	118	138
 Scatter Cushion 400mm x 400mm (batches of 3 in the same fabric)	CUSH- ION/400/3	W400 D400	129	151	162	181	200	227	256	296
 Scatter Cushion 500mm x 500mm	CUSH- ION/500/1	W500 D500	57	70	77	89	100	116	133	157
 Scatter Cushion 500 x 500 (batches of 2 in the same fabric)	CUSH- ION/500/2	W500 D500	100	113	120	132	143	159	176	200

If fabrics in two or more fabric groups are used on one product it will be priced in the highest group. For any patterned or velvet fabrics a surcharge will be added to cover the additional fabric usage.

Power Connections

To further enhance the functionality of our soft seating, we can offer several of our ranges with power sockets built into the furniture and in the case of our booths the option of mounting the power module on the table is also available.

The power sockets for the furniture come in a variety of finishes and fit flush to the fabric to respect the overall appearance of the furniture and to help avoid snagging. They can provide Type A and C USB charging and fused UK or international sockets and in addition the on-desk units provide HDMI connectivity.

The units comply with BS 5733 and a choice of 3.15A and 5A fuses are available to comply with BS 6396. All standard options come with a 1 metre mains lead to a 3 pole connector.

We have also recently introduced the option of battery powered power connections that remove the requirement to site the seating units near to a mains power source.

Please enquire for prices and specific options/ recommendations.

Caplet: Booth table power module

- Twin USB Type C adaptive fast charger
- 1 x UK socket
- 1 x 3A resettable circuit breaker
- Fitted with 1.5m cable to 3-pole GST male connector (starter lead sold separately)
- Supplied with c-clamp fixing to fit desk thicknesses between 11mm and 30mm
- Available in black and white, and a range of colours



Porthole 65: Booth and Modular Seating, fitted in Seat Base

Please note: Starter lead to be specified and priced individually

- Diameter 90mm
- 1 x UK socket
- USB Type A 18W quick charging socket and USB Type C 65W adaptive fast charging socket
- Fitted with 1.5m cable to 3-pole GST male connector with a hand fixing nut, to secure the module to a standard 80mm grommet hole (for desk thicknesses between 12mm and 42mm)
- Available in black, white and grey



Lunar: Booth and Modular Seating, fitted in Seat Base

- Diameter 140mm
- Fixed format in-desk power module offering 2x UK socket, 2x resettable 3A circuit breakers and a dual port Type A/C adaptive fast charger with a maximum PD65W for charging laptops, tablets and smart phones and a data keystone port that can be used with a range of data keystone couplers.
- 2 x UK socket
- 2 x thermal fuse
- USB Type A 18W quick charging socket and USB Type C 65W adaptive fast charging socket



Upholstery and Re-Upholstery Services

rhbr offers bespoke, made-to-measure upholstery services encompassing a wide range of product including.

- banquette seating
- headboards for hotels and student accommodation
- retail displays
- day beds
- window seats
- bolsters and cushions

Let us know what you need and we will do the rest.

As the sustainability agenda gathers pace, we are also doing an increasing volume of re-upholstery for a vast range of seating across environments ranging from bars, restaurants and hotels to cinemas and theatres, universities to commercial interiors, libraries to healthcare settings.





24/7, Bariatric, & Task Chairs

rhbr's office seating provides a capsule collection of best in class seating, engineered to provide user adaptability, durability and real value for money.

The common denominator is that every one of our chairs is designed with good posture first and foremost – most of us spend too much time sitting at a desk or terminal and providing the best possible support for the back and lumbar is vital.

In addition to Task Chairs, rhbr provides high quality, durable 24/7 and Bariatric seating, enabling all organisations to fulfil their obligation to provide equipment for their employees that is fit for purpose and allows them to undertake their work safely.





NOTE: our Bariatric Seating is weight rated to 50 stone.



Custom
Fabrics
Available





Further
product
info

	Eon	119
	Excelsior	120
	Excelsior Wood	120
	Ashton	121
	Century	122

Eon

24/7 chair suitable for use up to 23 stone.



Product Name	Product Code	Dimensions	Fabric Groups							
			0	1	2	3	4	5	6	7
 Eon Medium Back	260	H835-925 W550 D520 SH470-600 F670	302	322	332	350	367	391	418	454
 Eon High Back	262	H925-1030 W550 D520 SH470-600 F670	316	336	347	365	382	406	433	469



If fabrics in two or more fabric groups are used on one product it will be priced in the highest group. For any patterned or velvet fabrics a surcharge will be added to cover the additional fabric usage.

Product Name	Product Code	Dimensions	Std Prod Price	Fabric Groups							
				0	1	2	3	4	5	6	7
Pump up lumbar (no ply)	1002		19								
12" Draughtsman's kit	1003/EON		91								
14" Draughtsman's kit	1004/EON		92								
Height adjustable arms	1006/EON		49								
Ring arms	1009/EON		23								
Fold back arms	10011/EON		23								

Excelsior

Bariatric chair certified to accommodate weights of up to 50 stone.



Product Name	Product Code	Dimensions	Fabric Groups								
			0	1	2	3	4	5	6	7	
 High Back Swivel	660XL	H1080-1190 W590 D510 SH425-535 F700	1,145	1,191	1,216	1,256	1,296	1,351	1,413	1,497	
 High Back Swivel with no arms	660XL/NA	H1080-1190 W590 D510 SH425-535 F700	1,025	1,071	1,095	1,136	1,175	1,231	1,292	1,376	

If fabrics in two or more fabric groups are used on one product it will be priced in the highest group. For any patterned or velvet fabrics a surcharge will be added to cover the additional fabric usage.

Excelsior Wood

Bariatric chair certified to accommodate weights of up to 50 stone.





Product Name	Product Code	Dimensions	Fabric Groups								
			0	1	2	3	4	5	6	7	
 Excelsior Wood	671	H890 W830 D560 SH490	768	826	856	907	957	1,027	1,104	1,209	

If fabrics in two or more fabric groups are used on one product it will be priced in the highest group. For any patterned or velvet fabrics a surcharge will be added to cover the additional fabric usage.

Ashton



Ashton has been designed to provide a minimalist, contemporary aesthetic, whilst offering an exceptional array of features at a very affordable price to provide comfort and support throughout the day.

Product Name	Product Code	Dimensions	Fabric Groups								
			0	1	2	3	4	5	6	7	
 Ashton Chair without arms, body balance mech, no seat slider	ASHTON/NA	H1000-1100 W480 D520 SH450-560	349	371	382	401	420	447	476	515	
 Ashton Chair with arms, body balance mech, no seat slider	ASHTON/A	H1000-1100 W670 D520 SH450-560	392	414	426	445	464	490	519	559	

If fabrics in two or more fabric groups are used on one product it will be priced in the highest group. For any patterned or velvet fabrics a surcharge will be added to cover the additional fabric usage.



Century

Century is our budget task chair, providing all the basic functionality but unlike cheaper alternatives it is a robust choice and built to last.



Product Name	Product Code	Dimensions	Fabric Groups								
			0	1	2	3	4	5	6	7	
Medium Back	160	H930-1070 W490 D470 SH460-610	218	238	248	266	283	307	334	370	
Medium Back - ordered in batches of 6 in the same fabric	160/6	H930-1070 W490 D470 SH460-610	189	200	206	215	224	238	252	272	
Medium Back - ordered in batches of 50 in the same fabric	160/50	H930-1070 W490 D470 SH460-610	175	185	190	199	208	220	234	253	
Mesh back	160/M	H930-1070 W490 D470 SH460-610	283	303	313	331	348	373	399	436	
Mesh back - ordered in batches of 6 in the same fabric	160/M/6	H930-1070 W490 D470 SH460-610	258	265	269	275	281	289	298	310	
Mesh back - ordered in batches of 50 in the same fabric	160/M/50	H930-1070 W490 D470 SH460-610	239	246	249	255	260	268	276	288	
High Back	162	H1030-1170 W490 D470 SH460-610 F670	228	248	259	277	294	318	345	381	
High Back - ordered in batches of 6 in the same fabric	162/6	H1030-1170 W490 D470 SH460-610 F670	212	225	232	244	255	271	289	314	
High Back - ordered in batches of 50 in the same fabric	162/50	H1030-1170 W490 D470 SH460-610 F670	192	205	212	223	234	249	266	288	
Cantilever	170	H835 W490 D470 SH450	223	243	253	271	288	312	339	376	

Product Name	Product Code	Dimensions	Std Prod Price	Fabric Groups								
				0	1	2	3	4	5	6	7	
Pump up lumbar (no ply)	1002		19									
12" Draughtsman's kit (as upgrade)	1003/CENT		91									
14" Draughtsman's kit (as upgrade)	1004/CENT		92									
Height adjustable arms	1006/CENT		49									
Seat Slider	1007		36									
Ring arms	1009/CENT		23									
Independent seat and back mechanism (B3)	10032/U		12									
Independent seat and back mechanism (B3) with seat slider	10061/U		8									

If fabrics in two or more fabric groups are used on one product it will be priced in the highest group. For any patterned or velvet fabrics a surcharge will be added to cover the additional fabric usage.

Multipurpose

Our extensive range of multipurpose chairs and stools delivers both style and functionality in a wide variety of settings from office to café, education to healthcare.



Metal or
Wood
Legs



Custom
Fabrics
Available



Further
product
info



Bergen	127
Mata	131
Prima	136
Prima Nest & Stack	138
Renza	141









Bergen













Bergen's extensive range of chair and stool options makes it a go-to choice for a wide variety of environments and uses.

Product Name	Product Code	Dimensions	Std Prod Price	Fabric Groups							
				0	1	2	3	4	5	6	7
 Bergen Upholstered Lounge Chair, wood 4-leg frame	BERG/ LOUNGE/ WOOD	H780 W440 SD400 SH450		379	408	424	449	474	509	548	601
 Bergen Upholstered Lounge Chair, sled base	BERG/ LOUNGE/ SLED	H790 W440 SD400 SH480		379	408	424	449	474	509	548	601
Bergen upholstered seat pad	BERG/SEAT-PAD			115	125	131	140	149	161	175	194
 Bergen Side Chair, Sled base in black steel, Ash veneer	BERG/SIDE/ SLED/BLA	H790 W440 SD400 SH480	222								
 Bergen Side Chair, Sled base in black steel, Ash veneer Natural	BERG/SIDE/ SLED/NAT	H790 W440 SD400 SH480	229								
 Bergen Side Chair, Sled base in black steel, Ash veneer Raw	BERG/SIDE/ SLED/RAW	H790 W440 SD400 SH480	210								
 Bergen Upholstered Side Chair, Sled base in black steel	BERG/SIDE/ SLED/U	H790 W440 SD400 SH480		272	300	316	341	366	401	440	493
 Bergen Side Chair, 4-leg, black steel base, Ash veneer Black	BERG/SIDE/ STEEL/BLA	H790 W440 SD400 SH480	222								
 Bergen Side Chair, 4-leg, black steel base, Ash veneer Natural	BERG/SIDE/ STEEL/NAT	H790 W440 SD400 SH480	229								
 Bergen Side Chair, 4-leg, black steel base, Ash veneer Raw	BERG/SIDE/ STEEL/RAW	H790 W440 SD400 SH480	210								
 Bergen Upholstered Side Chair, 4-leg, black steel base	BERG/SIDE/ STEEL/U	H790 W440 SD400 SH480		267	296	311	337	362	397	435	488

If fabrics in two or more fabric groups are used on one product it will be priced in the highest group. For any patterned or velvet fabrics a surcharge will be added to cover the additional fabric usage.

Bergen











Product Name	Product Code	Dimensions	Std Prod Price	Fabric Groups								
				0	1	2	3	4	5	6	7	
 Bergen Side Chair, 4-leg, raw wood legs, Raw Ash shell	BERG/SIDE/ WOOD/RAW	H780 W440 SD400 SH450	260									
 Bergen Upholstered Side Chair, 4-leg, raw wood legs	BERG/SIDE/ WOOD/U	H780 W440 SD400 SH450		322	447	465	323	448	465	301	624	
 Bergen Side Chair, 4-leg, clear lacquer wood legs, Ash veneer Natural	BERG/SIDE/ WOOD/NAT	H780 W440 SD400 SH450	307									
 Bergen Side Chair, 4-leg, Black wood legs, Ash veneer Black	BERG/SIDE/ WOOD/BLA	H780 W440 SD400 SH450	292									
 Bergen Stool 750 Sled base in black steel, Ash veneer Black	BERG/HST/ STEEL/BLA	H900 W385 SD370 SH750	284									
 Bergen Stool 750 Sled base in black steel, Ash veneer Natural	BERG/HST/ STEEL/NAT	H900 W385 SD370 SH750	284									
 Bergen Stool 750 Sled base in black steel, Ash veneer Raw	BERG/HST/ STEEL/RAW	H900 W385 SD370 SH750	262									
 Bergen Upholstered Stool 750 Sled base in black steel	BERG/HST/ STEEL/U	H900 W385 SD370 SH750		334	363	379	404	429	464	503	556	
 Bergen Stool 650 Sled base in black steel, Ash veneer Black	BERG/MST/ SLED/BLA	H800 W385 D370 SH650	265									
 Bergen Stool 650 Sled base in black steel, Ash veneer Natural	BERG/MST/ SLED/NAT	H800 W385 D370 SH650	270									
 Bergen Stool 650 Sled base in black steel, Ash veneer Raw	BERG/MST/ SLED/RAW	H800 W385 D370 SH650	248									

If fabrics in two or more fabric groups are used on one product it will be priced in the highest group. For any patterned or velvet fabrics a surcharge will be added to cover the additional fabric usage.

Bergen



Product Name	Product Code	Dimensions	Std Prod Price	Fabric Groups								
				0	1	2	3	4	5	6	7	
 Bergen Upholstered Stool 650 Sled base in black steel	BERG/MST/ SLED/U	H800 W385 D370 SH650		301	322	333	351	369	394	422	459	
 Bergen Mid-Height Stool, 4-leg Raw wood, Ash veneer Raw	BERG/MST/ WOOD/RAW	H800 W385 D370 SH640	285									
 Bergen Upholstered Mid-Height Stool, 4-leg Raw wood	BERG/MST/ WOOD/U	H800 W385 D370 SH640		345	366	377	395	413	438	465	503	
 Bergen Mid-Height Stool, 4-leg clear lacquer, Ash veneer Natural	BERG/MST/ WOOD/NAT	H800 W385 D370 SH640	314									
 Bergen Mid-Height Stool, 4-leg Black wood, Ash veneer Black	BERG/MST/ WOOD/BLA	H800 W385 D370 SH640	314									
 Bergen HIGH, 4-leg Raw wood, Ash veneer Raw	BERG/HST/ WOOD/RAW	H900 W385 D370 SH740	301									
 Bergen Upholstered High Stool, 4-leg Raw wood	BERG/HST/ WOOD/U	H900 W385 D370 SH740		363	384	395	413	431	456	484	521	
 Bergen High Stool, 4-leg clear lacquer, Ash veneer Natural	BERG/HST/ WOOD/NAT	H900 W385 D370 SH740	326									
 Bergen High Stool, 4-leg Black wood, Ash veneer Black	BERG/HST/ WOOD/BLA	H900 W385 D370 SH740	322									



If fabrics in two or more fabric groups are used on one product it will be priced in the highest group. For any patterned or velvet fabrics a surcharge will be added to cover the additional fabric usage.



Mata 4 Leg





Mata has stood the test of time and continues to be a hugely successful product. It combines attractive design, robust construction, flexible shell, range of frames and colours to make it an obvious choice from classroom to cafeteria, office to waiting room, student accommodation to healthcare.

Product Name	Product Code	Dimensions	Std Prod Price	Fabric Groups								
				0	1	2	3	4	5	6	7	
 4 Leg Chair	SM4L	H700 W360 D350 SH380	77									
 4 Leg Chair	SM6L	H805 W430 D490 SH460	73									
Seat pad – individual	MATAUPHPAD			44	64	75	93	110	134	161	197	
Seat pad – batch of 2	MATAUPHPAD/2			39	49	54	63	72	84	97	115	
Seat pad – batch of 5	MATAUPHPAD/5			37	43	46	51	56	64	72	83	
Mata: Price band 31-100												
Mata Side 4L Size 6	SM6L/31-100	H805 W430 D490 SH460	68									
Mata: Price band 100+												
Mata Side 4L Size 6	SM6L>100	H805 W430 D490 SH460	62									

If fabrics in two or more fabric groups are used on one product it will be priced in the highest group. For any patterned or velvet fabrics a surcharge will be added to cover the additional fabric usage.

Mata Cantilever









Product Name	Product Code	Dimensions	Std Prod Price	Fabric Groups							
				0	1	2	3	4	5	6	7
 Reverse Cantilever Chair	SM4C	H660 W360 D410 SH380	96								
 Reverse Cantilever Chair	SM6C	H810 W430 D520 SH460	96								
Seat pad – individual	MATAUPHPAD			44	64	75	93	110	134	161	197
Seat pad – batch of 2	MATAUPHPAD/2			39	49	54	63	72	84	97	115
Seat pad – batch of 5	MATAUPHPAD/5			37	43	46	51	56	64	72	83
Mata: Price band 31-100											
Mata Cantilever Size 6	SM6C/31-100	H810 W430 D520 SH460	89								
Mata: Price band 100+											
Mata Cantilever Size 6	SM6C>100	H810 W430 D520 SH460	82								

If fabrics in two or more fabric groups are used on one product it will be priced in the highest group. For any patterned or velvet fabrics a surcharge will be added to cover the additional fabric usage.

Mata Swivel & Sled









Product Name	Product Code	Dimensions	Std Prod Price	Fabric Groups							
				0	1	2	3	4	5	6	7
 Mata TYPIST	MATATYPIST	H795-925 W610 D610 SH410-550	134								
 Sled Base (silver) Chair	SL6/S	H805 W500 D600 SH460	85								
Seat pad – individual	MATAUPH-PAD			44	64	75	93	110	134	161	197
Seat pad – batch of 2	MATAUPH-PAD/2			39	49	54	63	72	84	97	115
Seat pad – batch of 5	MATAUPH-PAD/5			37	43	46	51	56	64	72	83
Mata: Price band 31-100											
 Mata Sled chair - Silver Frame	SL6/S/31-100	H805 W500 D600 SH460	78								
 Mata Typist	MATATYP-IST/31-100	H795-925 W610 D610 SH410-550	122								
Mata: Price band 100+											
 Mata Sled chair - Silver Frame	SL6/S>100	H805 W500 D600 SH460	72								
 Mata Typist	MATATYP-IST>100	H795-925 W610 D610 SH410-550	110								

If fabrics in two or more fabric groups are used on one product it will be priced in the highest group. For any patterned or velvet fabrics a surcharge will be added to cover the additional fabric usage.



Mata High Stool











	Product Name	Product Code	Dimensions	Std Prod Price	Fabric Groups							
					0	1	2	3	4	5	6	7
	Mata High Sled 620mm high	MATA/SL-STOOL/S/62	H1020 W580 D580 SH640	119								
	Mata 4 Leg Stool - Silver	MATA/STOOL/S	H1000 W510 D500 SH620	111								
Mata: Price band 31-100												
	Mata High 4-Leg stool - Silver	MATA/STOOL/S/31-100	H1000 W510 D500 SH620	102								
	Mata High Sled Stool Silver 620mm High	MATA/SLSTOOL/S/62/31-100	H1020 W580 D580 SH640	109								
Mata: Price band 100+												
	Mata High 4-Leg stool - Silver	MATA/STOOL/S>100	H1000 W510 D500 SH620	93								
	Mata High Sled Stool Silver 620mm High	MATA/SLSTOOL/S/62>100	H1020 W580 D580 SH640	100								

If fabrics in two or more fabric groups are used on one product it will be priced in the highest group. For any patterned or velvet fabrics a surcharge will be added to cover the additional fabric usage.

Prima



Prima is a chair with exceptional durability and a wide range of options, which include a self-linking system and a choice of shells. It is certified for use up to 32 stone and stacks up to 10 high. A transporter trolley is available.

Product Name	Product Code	Dimensions	Std Prod Price	Fabric Groups							
				0	1	2	3	4	5	6	7
 4 Leg Chair Black Frame - Fully Upholstered	PRIMA/BF/UPH	H800 W520 D580 SH485		214	234	244	262	279	304	330	367
 4 Leg Chair Black Frame - Polyprop seat and back	PRIMA/BF/PP	H800 W520 D580 SH485	129								
 4 Leg Chair Black Frame - Upholstered seat and polyprop back	PRIMA/BF/UPH/PP	H800 W520 D580 SH485		186	206	216	234	251	275	302	338
Prima: Price band 21-60											
 Prima Chair Black - Upholstered	PRIMA/BF/UPH/21-60	H800 W520 D580 SH485		194	207	214	226	237	253	271	295
 Prima Chair Black - Polyprop	PRIMA/BF/PP/21-60	H800 W520 D580 SH485	119								
 Prima Chair Black - Upholstered Seat & Polyprop Back	PRIMA/BF/UPH/PP/21-60	H800 W520 D580 SH485		160	166	170	175	181	189	198	210
Prima: Price band 60+											
 Prima Chair Black - Upholstered	PRIMA/BF/UPH>60	H800 W520 D580 SH485		183	198	205	218	230	248	267	293
 Prima Chair Black - Polyprop	PRIMA/BF/PP>60	H800 W520 D580 SH485	109								
 Prima Chair Black - Upholstered Seat & Polyprop Back	PRIMA/BF/UPH/PP>60	H800 W520 D580 SH485		149	156	160	166	172	181	191	204

If fabrics in two or more fabric groups are used on one product it will be priced in the highest group. For any patterned or velvet fabrics a surcharge will be added to cover the additional fabric usage.







Product Name	Product Code	Dimensions	Std Prod Price	Fabric Groups							
				0	1	2	3	4	5	6	7
T-Shaped Arm Rest & Tablet	10052		101								
Fixed arms (Black) - pair	10053		64								
Right laptop tablet including arm (stacks up to 4 high)	10054		70								
Left laptop tablet including arm (stacks up to 4 high)	10055		70								
Right anti-panic tablet including arm (non-stacking)	10056		772								
Left anti-panic tablet including arm (non-stacking)	10057		72								
T-Shaped Arm Rest (PAIR)	10058		77								
Extension link connector	10059		14								
Castors	PRIMACASTORS		43								



Prima Nest & Stack



This unique tablet chair stacks with the tablet to at least 8 high and also nests for storage with the seat tipped up to avoid the risks associated with lifting the chair to stack.

Product Name	Product Code	Dimensions	Std Prod Price	Fabric Groups							
				0	1	2	3	4	5	6	7
 Prima nest and stack - Fully Upholstered, castors & glides	PRIMANEST/UPH/CG	H810 W530 D780 SD460 SH440	258	278	289	306	324	348	375	411	
 Prima nest and stack - Upholstered Seat & PP Back, castors & glides	PRIMANEST/UPH/PP/CG	H810 W530 D780 SD460 SH440	267	287	297	315	332	356	383	419	
Prima N&S - PP seat & back, Castors & Glides	PRIMANEST/PP/CG	H810 W530 D780 SD460 SH440	180								
Prima Nest & Stack: Price band 21-60											
 Prima N&S - Fully Uph, Castors & Glides	PRIMANEST/UPH/CG/21-60	H810 W530 D780 SD460 SH440	236	250	257	268	280	296	313	337	
 Prima N&S - Uph seat & PP back, Castors & Glides	PRIMANEST/UPH/PP/CG/21-60	H810 W530 D780 SD460 SH440	236	242	246	252	257	265	274	286	
Prima N&S - PP seat & back, Castors & Glides	PRIMANEST/PP/CG/21-60	H810 W530 D780 SD460 SH440	167								
Prima Nest & Stack: Price band 60+											
 Prima N&S - Fully Uph, Castors & Glides	PRIMANEST/UPH/CG>60	H810 W530 D780 SD460 SH440	223	238	245	258	271	288	307	333	
 Prima N&S - Uph seat & PP back, Castors & Glides	PRIMANEST/UPH/PP/CG>60	H810 W530 D780 SD460 SH440	220	227	231	238	244	253	262	275	
Prima N&S - PP seat & back, Castors & Glides	PRIMANEST/PP/CG>60	H810 W530 D780 SD460 SH440	155								

If fabrics in two or more fabric groups are used on one product it will be priced in the highest group. For any patterned or velvet fabrics a surcharge will be added to cover the additional fabric usage.

Product Name	Product Code	Dimensions	Std Prod Price	Fabric Groups						
				0	1	2	3	4	5	6
T-Shaped Arm Rest & Tablet	10052		101							
Fixed arms (Black) - pair	10053		64							
Right laptop tablet including arm (stacks up to 4 high)	10054		70							
Left laptop tablet including arm (stacks up to 4 high)	10055		70							
Right anti-panic tablet including arm (non-stacking)	10056		772							
Left anti-panic tablet including arm (non-stacking)	10057		72							
T-Shaped Arm Rest (PAIR)	10058		77							
Extension link connector	10059		14							
Castors	PRIMACASTORS		43							



Renza



Renza has flair and functionality, making it an ideal solution for the meeting room and front office. Both 4-leg and cantilever frames are stackable.



	Product Name	Product Code	Dimensions	Fabric Groups							
				0	1	2	3	4	5	6	7
	4-Leg Mesh Back - Chrome Frame	REN-ZA/4LEG/MESH	H830 W560 D550 SH470	249	259	265	274	283	296	310	328
	4-Leg Medium Back Upholstered	REN-ZA/4LEG/MB	H830 W560 D550 SH470	243	259	267	282	296	315	337	366
	4-Leg High Back Upholstered	REN-ZA/4LEG/HB	H920 W560 D550 SH470	272	286	294	306	318	334	353	378
	Cantilever Mesh Back	RENZA/CANT/MESH	H845 W660 D560 SH450	259	270	275	284	293	306	320	339
	Cantilever Medium Back Upholstered	RENZA/CANT/MB	H845 W660 D560 SH450	267	283	292	306	320	340	361	391
	Cantilever High Back Upholstered	RENZA/CANT/HB	H940 W660 D560 SH450	283	296	304	316	328	345	363	388
	Swivel Mesh Back	RENZA/SWI/MESH	H885-975 W790 D490 SH465-555	274	285	290	300	308	321	335	354
	Swivel Medium Back Upholstered	RENZA/SWI/MB	H885-975 W790 D490 SH465-555	306	322	331	345	359	378	400	429
	Swivel High Back Upholstered	RENZA/SWI/HB	H985-1075 W790 D490 SH465-555	321	335	342	355	367	383	402	427

If fabrics in two or more fabric groups are used on one product it will be priced in the highest group. For any patterned or velvet fabrics a surcharge will be added to cover the additional fabric usage.

Product Name	Product Code	Dimensions	Fabric Groups							
			0	1	2	3	4	5	6	7
Renza: Price band 11-20										
4-Leg Chrome Frame with Mesh Back	REN-ZA/4LEG/MESH/11-20	H830 W560 D550 SH470	222	233	238	248	257	270	284	303
4-Leg Chrome Frame with Medium Uph Back	REN-ZA/4LEG/MB/11-20	H830 W560 D550 SH470	220	236	245	259	274	294	316	346
4-Leg Chrome Frame with High Uph Back	REN-ZA/4LEG/HB/11-20	H920 W560 D550 SH470	244	258	266	278	291	308	327	352
Cantilever Chrome Frame with Mesh Back	RENZA/CANT/MESH/11-20	H845 W660 D560 SH450	231	241	247	256	265	278	292	312
Cantilever Chrome Frame with Medium Uph Back	RENZA/CANT/MB/11-20	H845 W660 D560 SH450	240	257	266	280	294	314	336	366
Cantilever Chrome Frame with High Uph Back	RENZA/CANT/HB/11-20	H940 W660 D560 SH450	253	267	274	287	299	316	335	361
Swivel Base with Mesh Back	RENZA/SWI/MESH/11-20	H885-975 W790 D490 SH465-555	244	255	260	269	279	291	306	325
Swivel Base with Medium Uph Back	RENZA/SWI/MB/11-20	H885-975 W790 D490 SH465-555	274	290	299	313	327	347	369	399
Swivel Base with High Uph Back	RENZA/SWI/HB/11-20	H985-1075 W790 D490 SH465-555	286	300	308	320	332	349	368	394

If fabrics in two or more fabric groups are used on one product it will be priced in the highest group. For any patterned or velvet fabrics a surcharge will be added to cover the additional fabric usage.

Product Name	Product Code	Dimensions	Fabric Groups							
			0	1	2	3	4	5	6	7
Renza: Price band 20+										
4-Leg Chrome Frame with Mesh Back	REN-ZA/4LEG/MESH>20	H830 W560 D550 SH470	195	206	212	221	231	244	258	278
4-Leg Chrome Frame with Medium Uph Back	REN-ZA/4LEG/MB>20	H830 W560 D550 SH470	197	213	222	237	252	272	294	325
4-Leg Chrome Frame with High Uph Back	REN-ZA/4LEG/HB>20	H920 W560 D550 SH470	216	231	238	251	263	281	300	326
Cantilever Chrome Frame with Mesh Back	RENZA/CANT/MESH>20	H845 W660 D560 SH450	202	213	219	228	238	251	265	285
Cantilever Chrome Frame with Medium Uph Back	RENZA/CANT/MB>20	H845 W660 D560 SH450	214	230	239	254	269	289	311	342
Cantilever Chrome Frame with High Uph Back	RENZA/CANT/HB>20	H940 W660 D560 SH450	223	238	245	258	270	288	307	333
Swivel Base with Mesh Back	RENZA/SWI/MESH>20	H885-975 W790 D490 SH465-555	213	224	230	239	249	262	276	296
Swivel Base with Medium Uph Back	RENZA/SWI/MB>20	H885-975 W790 D490 SH465-555	241	258	267	282	296	316	339	369
Swivel Base with High Uph Back	RENZA/SWI/HB>20	H985-1075 W790 D490 SH465-555	251	265	273	286	298	315	335	361

If fabrics in two or more fabric groups are used on one product it will be priced in the highest group. For any patterned or velvet fabrics a surcharge will be added to cover the additional fabric usage.

Industrial & Technical

rhbr has a large range of industrial and technical seating that is best in class.

Combining the comfort and ergonomic needs of the individual with the dynamic needs of industrial or technical environments requires a specialist approach – we have the range of seating designed and constructed to meet all these needs.

Foot-operated gas-lift is available for all our industrial seating ranges – please enquire.

Suitability Key

To help with specifying the most suitable seating for your requirements, the symbols below are shown alongside the seating appropriate for the areas indicated.

					
Laboratory	Sterile Hygiene	Industrial Technical	ESD Static Safe	HEPA Filter	Medical Grade



Saddle & Perch	147
TechChair & TechStools	148
PU TechChair & TechStools	151
Static Safe TechChair & TechStools	152
Static Safe & Sterile TechChair & Tech Stools	154
Medical Grade Clean Room TechChairs	157



Further product info



Saddle & Perch

Ergonomic shaped stools designed to encourage good posture.
Ideal for use with a height adjustable or sit-stand desk.



Laboratory



Industrial Technical

Product Name	Product Code	Dimensions	Std Prod Price	Fabric Groups								
				0	1	2	3	4	5	6	7	
PU Saddle with Black Polyprop Base	201/B/P	H600-780 W640 D590 SH600-780 F610	188									
PU Saddle with Black Steel Base	201/B	H600-780 W640 D590 SH600-780 F610	203									
PU Saddle with Chrome Base	201/CH	H600-780 W640 D590 SH600-780 F610	231									
PU Stool Perch with Black Poly Base	205	H650-840 W333 D350 SH530-715 F610	156									
Upholstered Saddle with Black Poly Base	202/B/P	H555-730 W640 D590 SH555-730		178	199	211	229	247	273	301	339	
Upholstered Saddle with Aluminium Base	202/CH	H555-730 W640 D590 SH555-730		219	240	251	269	287	312	340	378	

If fabrics in two or more fabric groups are used on one product it will be priced in the highest group. For any patterned or velvet fabrics a surcharge will be added to cover the additional fabric usage.

25" Chrome base for Saddle only (as upgrade)	10013/U	45
Black steel 5-star base for Saddle only	10014/U	17
Tilt mechanism for Saddle (as upgrade)	10017	38
Tilt mechanism for Saddle (as upgrade)	10017(Saddle Upholstered)	38

TechChair & TechStools



Technical industrial seating that is best in class, meeting the rigours of demanding environments whilst providing comfort and support for the individual.

Product Name	Product Code	Dimensions	Fabric Groups								
			0	1	2	3	4	5	6	7	
TechChair High	TC101B/O	H960-1310 W500 D470 SH570-820 F710	325	350	363	385	406	436	469	515	
TechChair High - Batches OF 2	TC101B/O x 2	H960-1310 W500 D470 SH570-820 F710	305	326	337	355	373	399	427	465	
TechChair Medium	TC102/B/O	H930-1190 W500 D470 SH520-710 F710	323	348	361	383	404	434	467	513	
TechChair Medium - Batches of 2	TC102/B/O x 2	H930-1190 W500 D470 SH520-710 F710	303	324	335	353	371	397	425	463	
TechChair Low	TC103B/O	H870-1070 W500 D470 SH440-580 F670	259	284	297	319	341	371	404	449	
TechChair Low - Batches of 2	TC103B/O x 2	H870-1070 W500 D470 SH440-580 F670	241	262	274	292	310	336	364	402	
TechStool High	TC108	H650-810 W420 D420 SH650-810 F710	246	267	278	296	314	339	367	405	
TechStool High - Batches of 3	TC108 x 3	H650-810 W420 D420 SH650-810 F710	224	231	235	241	247	255	265	277	
TechStool Medium	TC109	H570-690 W420 D420 SH570-690 F710	244	265	276	294	312	337	365	403	
TechStool Medium - Batches of 3	TC109 x 3	H570-690 W420 D420 SH570-690 F710	222	229	233	239	245	253	263	275	
TechStool Low	TC110	H440-570 W420 D420 SH440-570 F670	189	210	221	239	257	282	309	347	
TechStool Low - Batches of 3	TC110 x 3	H440-570 W420 D420 SH440-570 F670	168	175	179	185	191	200	209	222	

If fabrics in two or more fabric groups are used on one product it will be priced in the highest group. For any patterned or velvet fabrics a surcharge will be added to cover the additional fabric usage.



Height adjustable arms	1006/TECH	47
Brake loaded soft tyre castors	10023/U	30
Brake unloaded soft tyre castors	10024/U	17
Brake unloaded hardwheel castors	10025/U	5
Independent seat and back mechanism S3 (as upgrade)	10032/U	10

PU TechChair & TechStools

This PU range is our own design with a larger seat and back than other PU chairs available on the market making them more comfortable and more suitable for prolonged use.

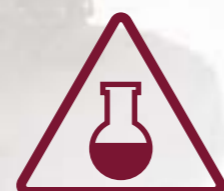

Laboratory



Industrial Technical

Product Name	Product Code	Dimensions	Std Prod Price	Fabric Groups							
				0	1	2	3	4	5	6	7
PU Chair High	TCPU4	H910-1270 W470 D450 SH580-840 F710	407								
PU Chair Medium	TCPU5	H830-1120 W470 D450 SH510-700 F710	405								
PU Chair Low	TCPU6	H750-980 W470 D450 SH430-570 F670	358								
PU Stool High	PU151	H530-780 W350 D350 SH530-780 F710	194								
PU Stool Medium	PU152	H470-660 W350 D350 SH470-660 F710	192								
PU Stool Low	PU153	H410-540 W350 D350 SH410-540 F670	152								

If fabrics in two or more fabric groups are used on one product it will be priced in the highest group. For any patterned or velvet fabrics a surcharge will be added to cover the additional fabric usage.

Brake loaded soft tyre castors	10023/U	30
Brake unloaded soft tyre castors	10024/U	17
Brake unloaded hardwheel castors	10025/U	5
Independent seat and back mechanism S3 (as upgrade)	10032/U	10

Static Safe TechChair & TechStools



Specialist Electro-Static Discharge (ESD) fabric to dissipate static charge continuously from the body. Developed for environments where sudden high voltage discharge can cause a dangerous source of ignition for flammable substances or cause damage to delicate electronics.

Product Name	Product Code	Dimensions	Fabric Groups								
			0	1	2	3	4	5	6	7	
ESD Chair High	TC201B/O	H950-1290 W500 D470 SH560-810 F710	411	436	449	471	492	522	556	601	
ESD Chair High - Batches of 2	TC201B/O x 2	H950-1290 W500 D470 SH560-810 F710	394	415	426	445	463	488	516	555	
ESD Chair Medium	TC202B/O	H920-1180 W500 D470 SH510-700 F710	410	435	448	470	491	521	555	600	
ESD Chair Medium - Batches of 2	TC202B/O x 2	H920-1180 W500 D470 SH510-700 F710	393	414	425	444	462	487	515	554	
ESD Chair Low	TC203B/O	H860-1060 W500 D470 SH430-570 F670	411	436	449	471	492	523	556	601	
ESD Chair Low - Batches of 2	TC203B/O x 2	H860-1060 W500 D470 SH430-570 F670	394	415	426	445	463	488	516	555	
ESD Stool High	TC208	H510-760 W420 D420 SH530-780 F710	282	292	297	306	315	328	342	361	
ESD Stool High - Batches of 6	TC208 x 6	H510-760 W420 D420 SH530-780 F710	252	256	259	262	266	271	277	285	
ESD Stool Medium	TC209	H460-650 W420 D420 SH480-670 F710	284	294	300	309	318	330	344	363	
ESD Stool Medium - Batches of 6	TC209 x 6	H460-650 W420 D420 SH480-670 F710	254	259	261	265	268	274	280	287	
ESD Stool Low	TC210 A	H356-526 W420 D420 SH376-546 F670	291	302	307	316	325	338	352	371	
ESD Stool Low - Batches of 6	TC210 A x 6	H356-526 W420 D420 SH376-546 F670	261	266	268	272	276	281	287	294	













If fabrics in two or more fabric groups are used on one product it will be priced in the highest group. For any patterned or velvet fabrics a surcharge will be added to cover the additional fabric usage.



Brake loaded soft tyre ESD castors (Upgrade from Glides)	10021/U - GLIDES (TC210, TC202, TC208, TC209)	11
Brake loaded soft tyre ESD castors (Upgrade from Castors)	10021/U - CASTORS (TC203, TC210)	11
Brake unloaded soft tyre ESD castors - set of 5 (Upgrade from Castors)	10022/U - CASTORS	2

Static Safe & Sterile Static Safe & Sterile TechChair & Tech Stools

Specialist Electro-Static Discharge (ESD) vinyl to dissipate static charge continuously from the body with HEPA filter for hygienic design. Developed for environments where sudden high voltage discharge can cause a dangerous source of ignition for flammable substances or cause damage to delicate electronics, and where areas must be kept sterile.

Product Name	Product Code	Dimensions	Fabric Groups									
			0	1	2	3	4	5	6	7		
 ESD & Sterile Chair High	TC304B/O	H950-1290 W500 D470 SH560-810 F710	437	462	475	497	518	548	582	627		
 ESD & Sterile Chair High - Batches of 2	TC304B/O x 2	H950-1290 W500 D470 SH560-810 F710	419	440	451	470	488	513	541	580		
 ESD & Sterile Chair Medium	TC305B/O	H920-1180 W500 D470 SH510-700 F710	440	464	478	499	521	551	584	629		
 ESD & Sterile Chair Medium - Batches of 2	TC305B/O x 2	H920-1180 W500 D470 SH510-700 F710	422	443	454	472	490	516	544	582		
 ESD & Sterile Chair Low	TC306/O	H860-1060 W500 D470 SH430-570 F670	439	464	477	499	520	551	584	629		
 ESD & Sterile Chair Low - Batches of 2	TC306/O x 2	H860-1060 W500 D470 SH430-570 F670	421	442	453	472	490	515	543	582		
 ESD & Sterile Stool High	TC308	H510-760 W420 D420 SH530-780 F710	282	292	297	306	315	328	342	361		
 ESD & Sterile Stool High - Batches of 6	TC308 x 6	H510-760 W420 D420 SH530-780 F710	262	266	268	272	276	281	287	295		
 ESD & Sterile Stool Medium	TC309	H460-650 W420 D420 SH480-670 F710	284	294	300	309	318	330	344	363		
 ESD & Sterile Stool Medium - Batches of 6	TC309 x 6	H460-650 W420 D420 SH480-670 F710	264	268	271	274	278	283	289	297		
 ESD & Sterile Stool Low	TC310	H356-526 W420 D420 SH376-546 F670	278	288	294	303	312	325	338	357		
 ESD & Sterile Stool Low - Batches of 6	TC310 x 6	H356-526 W420 D420 SH376-546 F670	258	263	265	269	273	278	284	291		









Brake loaded soft tyre ESD castors (Upgrade from Glides)	10021/U - GLIDES (TC305,TC304, TC308, TC309)	11
Brake loaded soft tyre ESD castors (Upgrade from Castors)	10021/U - CASTORS(TC306, TC310)	11
Brake unloaded soft tyre ESD castors - set of 5 (Upgrade from Glides)	10022/U - GLIDES	35

If fabrics in two or more fabric groups are used on one product it will be priced in the highest group. For any patterned or velvet fabrics a surcharge will be added to cover the additional fabric usage.

Medical Grade Clean Room TechChairs

Medical grade vinyl is treated to be antimicrobial, flame retardant, and resistant to odour and liquids common in the healthcare industry. HEPA filter for hygienic design.

Product Name	Product Code	Dimensions	Fabric Groups							
			0	1	2	3	4	5	6	7
 Medical Grade Chair High	TC311B/O	H950-1290 W500 D470 SH560-810 F710	419	444	457	479	501	531	564	609
 Medical Grade Chair High - Batches of 2	TC311B/O x 2	H950-1290 W500 D470 SH560-810 F710	402	423	434	453	471	496	524	563
 Medical Grade Chair Medium	TC312/O	H920-1180 W500 D470 SH510-700 F710	422	447	460	482	503	533	567	612
 Medical Grade Chair Medium - Batches of 2	TC312/O x 2	H920-1180 W500 D470 SH510-700 F710	405	426	437	455	473	499	527	565
 Medical Grade Chair Low	TC313B/O	H860-1060 W500 D470 SH430-570 F670	367	392	405	427	449	479	512	557
 Medical Grade Chair Low - Batches of 2	TC313B/O x 2	H860-1060 W500 D470 SH430-570 F670	352	373	384	402	421	446	474	512

If fabrics in two or more fabric groups are used on one product it will be priced in the highest group. For any patterned or velvet fabrics a surcharge will be added to cover the additional fabric usage.

Brake loaded soft tyre castors	10023/U	30
Brake unloaded soft tyre castors	10024/U	17
Brake unloaded hardwheel castors	10025/U	5

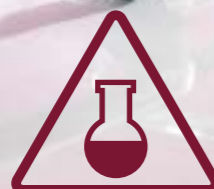

Laboratory



Industrial Technical



HEPA Filter



Medical Grade

Beams

For public spaces and waiting areas, beam seating is often the best solution and rhbr has one of the widest ranges available in the market. Some of our most popular multipurpose chairs can be beam configured and we also have a strong offering of specific beam seating. All in all, this range combines quality with cost-effectiveness and is designed throughout to meet the practical needs of public spaces from cleaning and maintenance to security and durability.



Custom
Fabrics
Available



Further
product
info



Mata Beam	161
Prima Beam	163
Tala	171













Mata Beam



Fresh, fun and modern, the Mata is superbly engineered for strength and durability. Its 'S' shaped back provides excellent support and flexibility for all ages. The Mata family consists of a 4-leg, sled base, cantilever, and swivel chair, 4-leg and sled base high stools, and a beam option.







Product Name	Product Code	Dimensions	Std Prod Price	Fabric Groups								
				0	1	2	3	4	5	6	7	
Fixed Seat Beam - 2 Seat	MATABEAM2	H830 W950 D510 SH450	303									
 Fixed Seat Beam - 3 Seat	MATABEAM3	H830 W1400 D510 SH450	475									
 Fixed Seat Beam - 4 Seat	MATABEAM4	H830 W1900 D510 SH450	580									
 Fixed Seat Beam - 5 Seat	MATABEAM5	H830 W2400 D510 SH450	687									
Mata Beam: Price band 60-120 seats												
Mata 2-Seater Beam	MATABEAM2/ 61-120	H830 W950 D510 SH450	277									
 Mata 3-Seater Beam	MATABEAM3/ 61-120	H830 W1400 D510 SH450	431									
 Mata 4-Seater Beam	MATABEAM4/ 61-120	H830 W1900 D510 SH450	527									
 Mata 5-Seater Beam	MATABEAM5/ 61-120	H830 W2400 D510 SH450	623									
Mata Beam: Price band 120+ seats												
Mata 2-Seater Beam	MATABEAM2 >120	H830 W950 D510 SH450	251									
 Mata 3-Seater Beam	MATABEAM3 >120	H830 W1400 D510 SH450	388									
 Mata 4-Seater Beam	MATABEAM4 >120	H830 W1900 D510 SH450	473									
 Mata 5-Seater Beam	MATABEAM5 >120	H830 W2400 D510 SH450	560									
Mata Beams drilling for floor fixing	MATABEAM/FF		30									



Prima Beam Fixed Seat



Fully Upholstered

Product Name	Product Code	Dimensions	Fabric Groups								
			0	1	2	3	4	5	6	7	
 Fixed Upholstered Seat Beam - 2 Seat	PF332	H835 W1200 D560 SH480	603	627	640	661	682	711	743	787	
 Fixed Upholstered Seat Beam - 3 Seat	PF333	H835 W1800 D560 SH480	839	871	888	916	944	982	1,025	1,083	
Fixed Upholstered Seat Beam - 4 Seat	PF334	H835 W2400 D560 SH480	1,044	1,086	1,109	1,146	1,182	1,233	1,289	1,365	
Fixed Upholstered Seat Beam - 5 Seat	PF335	H835 W3000 D560 SH480	1,258	1,310	1,337	1,383	1,428	1,491	1,560	1,655	
Prima Fixed Beam - Fully Upholstered: Price band 61-120 seats											
 Fixed Upholstered Seat Beam - 2 Seat	PF332/61-120	H835 W1200 D560 SH480	562	588	602	626	649	681	716	764	
 Fixed Upholstered Seat Beam - 3 Seat	PF333/61-120	H835 W1800 D560 SH480	781	816	834	866	896	939	986	1,050	
Fixed Upholstered Seat Beam - 4 Seat	PF334/61-120	H835 W2400 D560 SH480	972	1,018	1,043	1,084	1,124	1,179	1,241	1,325	
Fixed Upholstered Seat Beam - 5 Seat	PF335/61-120	H835 W3000 D560 SH480	1,172	1,229	1,260	1,310	1,360	1,429	1,505	1,609	
Prima Fixed Beam - Fully Upholstered: Price band 120+ seats											
 Fixed Upholstered Seat Beam - 2 Seat	PF332>120	H835 W1200 D560 SH480	521	550	565	590	615	650	689	741	
 Fixed Upholstered Seat Beam - 3 Seat	PF333>120	H835 W1800 D560 SH480	723	761	781	815	848	895	946	1,016	
Fixed Upholstered Seat Beam - 4 Seat	PF334>120	H835 W2400 D560 SH480	900	950	977	1,022	1,065	1,126	1,194	1,285	
Fixed Upholstered Seat Beam - 5 Seat	PF335>120	H835 W3000 D560 SH480	1,087	1,149	1,182	1,237	1,291	1,367	1,450	1,564	

If fabrics in two or more fabric groups are used on one product it will be priced in the highest group. For any patterned or velvet fabrics a surcharge will be added to cover the additional fabric usage.

Prima Beam Fixed Seat



Upholstered Seat & Black Polypropylene Back

Product Name	Product Code	Dimensions	Fabric Groups								
			0	1	2	3	4	5	6	7	
Fixed Upholstered Seat Beam with Polypropylene Back - 2 Seat	PF332/UPH/PP	H835 W1200 D560 SH480	622	642	653	670	688	712	738	775	
Fixed Upholstered Seat Beam with Polypropylene Back - 3 Seat	PF333/UPH/PP	H835 W1800 D560 SH480	861	885	898	919	940	969	1,001	1,045	
Fixed Upholstered Seat Beam with Polypropylene Back - 4 Seat	PF334/UPH/PP	H835 W2400 D560 SH480	1,065	1,089	1,102	1,123	1,144	1,173	1,205	1,249	
Fixed Upholstered Seat Beam with Polypropylene Back - 5 Seat	PF335/UPH/PP	H835 W3000 D560 SH480	1,290	1,326	1,345	1,377	1,408	1,452	1,500	1,565	

Prima Fixed Beam - Upholstered Seat & Black Polyprop Back: Price band 61-120 seats

Fixed Upholstered Seat Beam with Polypropylene Back - 2 Seat	PF332/UPH/PP/61-120	H835 W1200 D560 SH480	577	599	610	630	649	675	705	745
Fixed Upholstered Seat Beam with Polypropylene Back - 3 Seat	PF333/UPH/PP/61-120	H835 W1800 D560 SH480	797	823	837	860	883	915	950	998
Fixed Upholstered Seat Beam with Polypropylene Back - 4 Seat	PF334/UPH/PP/61-120	H835 W2400 D560 SH480	984	1,011	1,025	1,048	1,071	1,103	1,138	1,186
Fixed Upholstered Seat Beam with Polypropylene Back - 5 Seat	PF335/UPH/PP/61-120	H835 W3000 D560 SH480	1,195	1,234	1,255	1,290	1,325	1,372	1,425	1,497

Prima Fixed Beam - Upholstered Seat & Black Polyprop Back: Price band 120+ seats

Fixed Upholstered Seat Beam with Polypropylene Back - 2 Seat	PF332/UPH/PP>120	H835 W1200 D560 SH480	531	555	568	589	610	639	671	715
Fixed Upholstered Seat Beam with Polypropylene Back - 3 Seat	PF333/UPH/PP>120	H835 W1800 D560 SH480	732	761	776	802	827	862	900	952
Fixed Upholstered Seat Beam with Polypropylene Back - 4 Seat	PF334/UPH/PP>120	H835 W2400 D560 SH480	903	932	947	973	998	1,033	1,071	1,124
Fixed Upholstered Seat Beam with Polypropylene Back - 5 Seat	PF335/UPH/PP>120	H835 W3000 D560 SH480	1,099	1,142	1,165	1,203	1,241	1,293	1,351	1,430

If fabrics in two or more fabric groups are used on one product it will be priced in the highest group. For any patterned or velvet fabrics a surcharge will be added to cover the additional fabric usage.

Prima Beam Fixed Seat



Black Polypropylene

Product Name	Product Code	Dimensions	Std Prod Price	Fabric Groups						
				0	1	2	3	4	5	6
Fixed Black Polypropylene Seat Beam - 2 Seat	PF332/PP	H835 W1200 D560 SH480	471							
Fixed Black Polypropylene Seat Beam - 3 Seat	PF333/PP	H835 W1800 D560 SH480	642							
Fixed Black Polypropylene Seat Beam - 4 Seat	PF334/PP	H835 W2400 D560 SH480	783							
Fixed Black Polypropylene Seat Beam - 5 Seat	PF335/PP	H835 W3000 D560 SH480	931							

Prima Fixed Beam - Black Polyprop: Price band 61-120 seats

Fixed Black Polypropylene Seat Beam - 2 Seat	PF332/PP/61-120	H835 W1200 D560 SH480	434							
Fixed Black Polypropylene Seat Beam - 3 Seat	PF333/PP/61-120	H835 W1800 D560 SH480	590							
Fixed Black Polypropylene Seat Beam - 4 Seat	PF334/PP/61-120	H835 W2400 D560 SH480	719							
Fixed Black Polypropylene Seat Beam - 5 Seat	PF335/PP/61-120	H835 W3000 D560 SH480	857							

Prima Fixed Beam - Black Polyprop: Price band 120+ seats

Fixed Black Polypropylene Seat Beam - 2 Seat	PF332/PP>120	H835 W1200 D560 SH480	396							
Fixed Black Polypropylene Seat Beam - 3 Seat	PF333/PP>120	H835 W1800 D560 SH480	538							
Fixed Black Polypropylene Seat Beam - 4 Seat	PF334/PP>120	H835 W2400 D560 SH480	656							
Fixed Black Polypropylene Seat Beam - 5 Seat	PF335/PP>120	H835 W3000 D560 SH480	782							



Soft feel polyurethane arms 10065 61



Prima Beam Tip-Up Seat



Upholstered

Product Name	Product Code	Dimensions	Fabric Groups							
			0	1	2	3	4	5	6	7
Tip-Up Upholstered Seat Beam - 2 Seat	PT336	H790 W1200 D490 SH490	705	729	742	763	783	813	845	888
Tip-Up Upholstered Seat Beam - 3 Seat	PT337	H790 W1800 D490 SH490	985	1,017	1,034	1,063	1,090	1,129	1,172	1,230
 Tip-Up Upholstered Seat Beam - 4 Seat	PT338	H790 W2400 D490 SH490	1,238	1,280	1,302	1,339	1,375	1,426	1,482	1,559
Tip-Up Upholstered Seat Beam - 5 Seat	PT339	H790 W3000 D490 SH490	1,498	1,549	1,577	1,623	1,668	1,731	1,800	1,895
Prima Tip-Up Beam - Fully Upholstered: Price band 61-120 seats										
Prima Beam - Tip-Up Upholstered Seat Beam 2 Seat	PT336/61-120	H790 W1200 D490 SH490	655	681	695	718	741	773	808	856
Prima Beam - Tip-Up Upholstered Seat Beam 3 Seat	PT337/61-120	H790 W1800 D490 SH490	914	949	968	999	1,029	1,072	1,119	1,183
 Prima Beam - Tip-Up Upholstered Seat Beam 4 Seat	PT338/61-120	H790 W2400 D490 SH490	1,148	1,194	1,218	1,259	1,299	1,355	1,417	1,501
Prima Beam - Tip-Up Upholstered Seat Beam 5 Seat	PT339/61-120	H790 W3000 D490 SH490	1,390	1,447	1,477	1,528	1,577	1,646	1,723	1,827
Prima Tip-Up Beam - Fully Upholstered: Price band 120+ seats										
Prima Beam - Tip-Up Upholstered Seat Beam 2 Seat	PT336>120	H790 W1200 D490 SH490	614	638	651	672	693	722	754	798
Prima Beam - Tip-Up Upholstered Seat Beam 3 Seat	PT337>120	H790 W1800 D490 SH490	857	885	901	926	951	986	1,024	1,077
 Prima Beam - Tip-Up Upholstered Seat Beam 4 Seat	PT338>120	H790 W2400 D490 SH490	1,068	1,097	1,113	1,138	1,163	1,198	1,236	1,289
Prima Beam - Tip-Up Upholstered Seat Beam 5 Seat	PT339>120	H790 W3000 D490 SH490	1,305	1,348	1,371	1,409	1,447	1,499	1,557	1,635

If fabrics in two or more fabric groups are used on one product it will be priced in the highest group. For any patterned or velvet fabrics a surcharge will be added to cover the additional fabric usage.

Prima Beam Tip-Up Seat



Upholstered Seat & Black Polypropylene Back

Product Name	Product Code	Dimensions	Fabric Groups							
			0	1	2	3	4	5	6	7
Tip-Up Upholstered Seat Beam with Polypropylene Back - 2 Seat	PT336/UPH/PP	H790 W1200 D490 SH490	724	744	754	772	789	813	840	876
Tip-Up Upholstered Seat Beam with Polypropylene Back - 3 Seat	PT337/UPH/PP	H790 W1800 D490 SH490	1,013	1,037	1,050	1,071	1,091	1,120	1,153	1,196
 Tip-Up Upholstered Seat Beam with Polypropylene Back - 4 Seat	PT338/UPH/PP	H790 W2400 D490 SH490	1,267	1,291	1,304	1,325	1,346	1,375	1,407	1,451
Tip-Up Upholstered Seat Beam with Polypropylene Back - 5 Seat	PT339/UPH/PP	H790 W3000 D490 SH490	1,542	1,578	1,597	1,629	1,660	1,704	1,752	1,817

Prima Tip-Up Beam - Upholstered Seat & Black Polyprop Back: Price band 61-120

Tip-Up Upholstered Seat Beam with Polypropylene Back - 2 Seat	PT336/UPH/PP/61-120	H790 W1200 D490 SH490	669	691	703	722	741	768	797	837
Tip-Up Upholstered Seat Beam with Polypropylene Back - 3 Seat	PT337/UPH/PP/61-120	H790 W1800 D490 SH490	935	961	975	998	1,021	1,053	1,088	1,136
 Tip-Up Upholstered Seat Beam with Polypropylene Back - 4 Seat	PT338/UPH/PP/61-120	H790 W2400 D490 SH490	1,168	1,194	1,208	1,231	1,254	1,286	1,322	1,370
Tip-Up Upholstered Seat Beam with Polypropylene Back - 5 Seat	PT339/UPH/PP/61-120	H790 W3000 D490 SH490	1,424	1,463	1,484	1,519	1,553	1,601	1,654	1,726

Prima Tip-Up Beam - Upholstered Seat & Black Polyprop Back: Price band 120+ seats



Tip-Up Upholstered Seat Beam with Polypropylene Back - 2 Seat	PT336/UPH/PP>120	H790 W1200 D490 SH490	614	638	651	672	693	722	754	798
Tip-Up Upholstered Seat Beam with Polypropylene Back - 3 Seat	PT337/UPH/PP>120	H790 W1800 D490 SH490	857	885	901	926	951	986	1,024	1,077
 Tip-Up Upholstered Seat Beam with Polypropylene Back - 4 Seat	PT338/UPH/PP>120	H790 W2400 D490 SH490	1,068	1,097	1,113	1,138	1,163	1,198	1,236	1,289
Tip-Up Upholstered Seat Beam with Polypropylene Back - 5 Seat	PT339/UPH/PP>120	H790 W3000 D490 SH490	1,305	1,348	1,371	1,409	1,447	1,499	1,557	1,635

If fabrics in two or more fabric groups are used on one product it will be priced in the highest group. For any patterned or velvet fabrics a surcharge will be added to cover the additional fabric usage.



Prima Beam Tip-Up Seat





Black Polypropylene

Product Name	Product Code	Dimensions	Std Prod Price	Fabric Groups						
				0	1	2	3	4	5	6
 Tip-Up Black Polypropylene Seat Beam - 2 Seat	PT336/PP	H790 W1200 D490 SH490	564							
Tip-Up Black Polypropylene Seat Beam - 3 Seat	PT337/PP	H790 W1800 D490 SH490	792							
Tip-Up Black Polypropylene Seat Beam - 4 Seat	PT338/PP	H790 W2400 D490 SH490	983							
 Tip-Up Black Polypropylene Seat Beam - 5 Seat	PT339/PP	H790 W3000 D490 SH490	1,181							

Prima Tip-Up Beam - Black Polyprop: Price band 61-120 seats

 Tip-Up Black Polypropylene Seat Beam - 2 Seat	PT336/PP/61-120	H790 W1200 D490 SH490	518							
Tip-Up Black Polypropylene Seat Beam - 3 Seat	PT337/PP/61-120	H790 W1800 D490 SH490	727							
Tip-Up Black Polypropylene Seat Beam - 4 Seat	PT338/PP/61-120	H790 W2400 D490 SH490	901							
 Tip-Up Black Polypropylene Seat Beam - 5 Seat	PT339/PP/61-120	H790 W3000 D490 SH490	1,084							

Prima Tip-Up Beam - Black Polyprop: Price band 120 seats

 Tip-Up Black Polypropylene Seat Beam - 2 Seat	PT336/PP>120	H790 W1200 D490 SH490	472							
Tip-Up Black Polypropylene Seat Beam - 3 Seat	PT337/PP>120	H790 W1800 D490 SH490	661							
Tip-Up Black Polypropylene Seat Beam - 4 Seat	PT338/PP>120	H790 W2400 D490 SH490	819							
 Tip-Up Black Polypropylene Seat Beam - 5 Seat	PT339/PP>120	H790 W3000 D490 SH490	987							



Soft feel polyurethane arms 10065 61





Tala







Durable and functional, the powder-coated metal structure of the Tala makes it robust, easy to clean, and suitable for a wide range of environments.



Product Name	Product Code	Dimensions	Std Prod Price	Fabric Groups							
				0	1	2	3	4	5	6	7
Tala 2 Seater with Floor Fixing Leg	TALA/2/FF	H800 W1160 D615 SH440	710								
 Tala 2 Seater with Floor Fixing Leg & Arms	TALA/2/A/FF	H800 W1260 D615 SH440	790								
Tala 3 Seater with Floor Fixing Leg	TALA/3/FF	H800 W1710 D615 SH440	997								
 Tala 3 Seater with Floor Fixing Leg & Arms	TALA/3/A/FF	H800 W1810 D615 SH440	1,077								
Tala 4 Seater with Floor Fixing Leg	TALA/4/FF	H800 W2260 D615 SH440	1,292								
 Tala 4 Seater with Floor Fixing Leg & Arms	TALA/4/A/FF	H800 W2360 D615 SH440	1,374								
Tala 5 Seater with Floor Fixing Leg	TALA/5/FF	H800 W2800 D615 SH440	1,642								
Tala 5 Seater with Floor Fixing Leg & Arms	TALA/5/A/FF	H800 W2900 D615 SH440	1,726								

Floor Fixing Leg: Price band 41-80 seats

Tala 2 Seater with Floor Fixing Leg	TALA/2/FF/41-80	H800 W1160 D615 SH440	617								
 Tala 2 Seater with Floor Fixing Leg & Arms	TALA/2/A/FF/41-80	H800 W1260 D615 SH440	684								
Tala 3 Seater with Floor Fixing Leg	TALA/3/FF/41-80	H800 W1710 D615 SH440	865								
 Tala 3 Seater with Floor Fixing Leg & Arms	TALA/3/A/FF/41-80	H800 W1810 D615 SH440	933								

If fabrics in two or more fabric groups are used on one product it will be priced in the highest group. For any patterned or velvet fabrics a surcharge will be added to cover the additional fabric usage.

Product Name	Product Code	Dimensions	Std Prod Price	Fabric Groups						
				0	1	2	3	4	5	6
Tala 4 Seater with Floor Fixing Leg	TALA/4/FF/41-80	H800 W2260 D615 SH440	1,121							
 Tala 4 Seater with Floor Fixing Leg & Arms	TALA/4/A/FF/41-80	H800 W2360 D615 SH440	1,190							
Tala 5 Seater with Floor Fixing Leg	TALA/5/FF/41-80	H800 W2800 D615 SH440	1,424							
Tala 5 Seater with Floor Fixing Leg & Arms	TALA/5/A/FF/41-80	H800 W2900 D615 SH440	1,495							
Floor Fixing Leg: Price band 80+ seats										
Tala 2 Seater with Floor Fixing Leg	TALA/2/FF>80	H800 W1160 D615 SH440	523							
 Tala 2 Seater with Floor Fixing Leg & Arms	TALA/2/A/FF>80	H800 W1260 D615 SH440	579							
Tala 3 Seater with Floor Fixing Leg	TALA/3/FF>80	H800 W1710 D615 SH440	733							
 Tala 3 Seater with Floor Fixing Leg & Arms	TALA/3/A/FF>80	H800 W1810 D615 SH440	788							
Tala 4 Seater with Floor Fixing Leg	TALA/4/FF>80	H800 W2260 D615 SH440	949							
 Tala 4 Seater with Floor Fixing Leg & Arms	TALA/4/A/FF>80	H800 W2360 D615 SH440	1,006							
Tala 5 Seater with Floor Fixing Leg	TALA/5/FF>80	H800 W2800 D615 SH440	1,205							
Tala 5 Seater with Floor Fixing Leg & Arms	TALA/5/A/FF>80	H800 W2900 D615 SH440	1,263							
Tala 2 Seater with Slim Arm & Leg	TALA/2/SLIM	H800 W1160 D615 SH440	905							
 Tala 3 Seater with Slim Arm & Leg	TALA/3/SLIM	H800 W1710 D615 SH440	1,192							
Tala 4 Seater with Slim Arm & Leg	TALA/4/SLIM	H800 W2260 D615 SH440	1,482							
Tala 5 Seater with Slim Arm & Leg	TALA/5/SLIM	H800 W2800 D615 SH440	1,851							

Product Name	Product Code	Dimensions	Std Prod Price	Fabric Groups						
				0	1	2	3	4	5	6
Slim Leg & Arm: Price band 41-80 seats										
Tala 2 Seater with Slim Arm & Leg	TALA/2/SLIM/41-80	H800 W1160 D615 SH440	787							
 Tala 3 Seater with Slim Arm & Leg	TALA/3/SLIM/41-80	H800 W1260 D615 SH440	1,036							
Tala 4 Seater with Slim Arm & Leg	TALA/4/SLIM/41-80	H800 W1710 D615 SH440	1,286							
Tala 5 Seater with Slim Arm & Leg	TALA/5/SLIM/41-80	H800 W1810 D615 SH440	1,606							
Slim Leg & Arm: Price band 80+ seats										
Tala 2 Seater with Slim Arm & Leg	TALA/2/SLIM>80	H800 W1160 D615 SH440	669							
 Tala 3 Seater with Slim Arm & Leg	TALA/3/SLIM>80	H800 W1260 D615 SH440	879							
Tala 4 Seater with Slim Arm & Leg	TALA/4/SLIM>80	H800 W1710 D615 SH440	1,090							
Tala 5 Seater with Slim Arm & Leg	TALA/5/SLIM>80	H800 W1810 D615 SH440	1,361							
Product Name	Product Code	Dimensions	Fabric Groups							
			0	1	2	3	4	5	6	7
Upholstery Seat Pad	TALA/SP		64	76	82	93	103	117	133	154
Upholstery Back Pad	TALA/BP		52	61	66	74	82	93	106	123
Tala Accessories: Price band 41-80 seats										
Upholstery Seat Pad	TALA/SP/41-80		61	73	79	90	100	115	131	153
Upholstery Back Pad	TALA/BP/41-80		50	59	64	73	81	92	105	122
Tala Accessories: Price band 80+ seats										
Upholstery Seat Pad	TALA/SP>80		58	70	76	87	98	113	129	151
Upholstery Back Pad	TALA/BP>80		48	58	63	71	79	91	104	121
If fabrics in two or more fabric groups are used on one product it will be priced in the highest group. For any patterned or velvet fabrics a surcharge will be added to cover the additional fabric usage.										

Office, Task & Guest Chair Mechanisms

We offer a wide choice of chair mechanisms to provide a full range of adjustments to suit particular tasks and individual needs.

All mechanisms are of the finest quality and have only been selected after thousands of hours of continuous testing. All swivel chairs are fitted with top quality pneumatic gas height adjustments as standard.



Knee Tilt

Tilt mechanism can be locked in the upright position or free-floating. Seat and backrest are fixed. Adjustable tension control.



Synchro Mechanism

Fully synchronised 2:1 ratio mechanism enables seat and backrest angle to be adjusted to required position.



Seat Slider

Sliding seat mechanism increases seat depth and enhances leg support.



Inflatable Lumbar

Inflatable air bag built into seat backrest to adjust support for the lumbar region.



Height Adjustable Back with Wheel Locking Screw

Backrest fully adjustable for height.



Easy Lift Back

Ratchet mechanism allows easy adjustment whilst seated.



Anti-Kick

This feature requires the user's to lean back into the chair before the backrest rake can be adjusted. This eliminates the risk of the backrest springing into the user's back.



Independent Seat and Back Mechanism

Seat and back can be independently adjusted to suit individual requirements using side adjustable tension control. Can be locked into position or remain free floating.



Special Order Castors

Soft wheeled castors for hard floor environments. Suitable for all rhbr chairs.

Brake Unloaded Castors

Castors brake when user gets off seat.

Brake Loaded Castors

Castors brake when user sits on seat.

Chair Sizing Guide

This sizing guide shows the approximate points we have taken for the indicative measurements of products throughout this brochure.

Every care has been taken to ensure the accuracy of these measurements, but we recommend to customers that product samples are requested in advance of any orders where absolute precision of dimensions will be critical.

Please note that different makes of castors, gas struts and foam do make a difference to height measurements.

For Soft Seating “D” dimension represents the overall depth of the unit. “SD” is also provided as the seat depth.

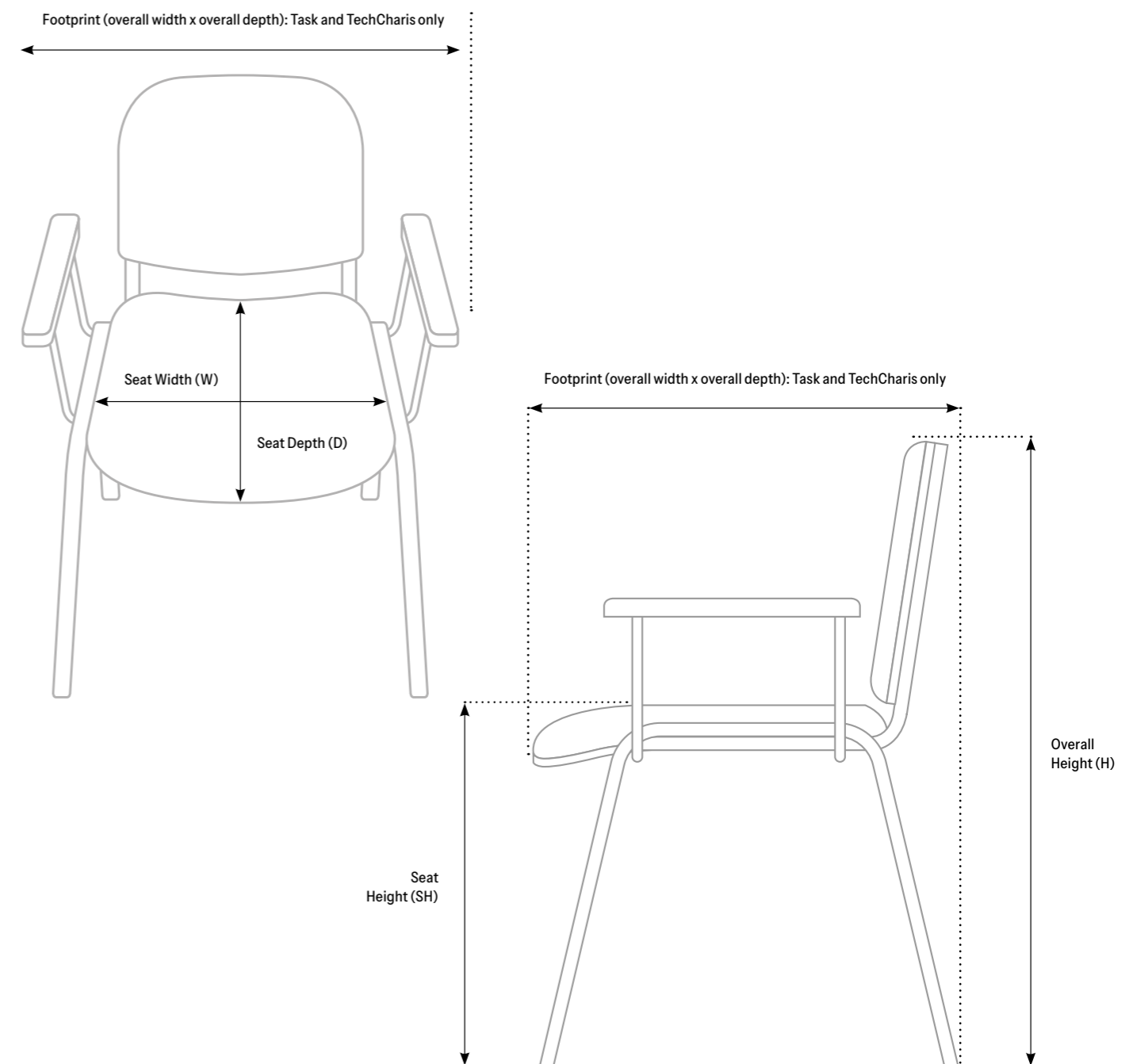

Professional Memberships & Accreditations

ISO 90001	Quality Assurance
ISO 14001	Environmental Management
PAS 2060	Carbon Neutrality
FISP	Furniture Sustainability Programme
FSC® Certified	Chain-of-custody certificate holders
FIRA	Quality & Production efficiency
Interface	Registered with a Carbon Reduction Pilot to start our journey to net zero*
SME Climate Hub	A global initiative that empowers small to medium sized companies to join the United Nations Race Zero campaign

*The programme is part of the accreditation process for ISO 14064 and PAS 2060 accreditation



Fabric Advice

Fabric makes a huge difference both to the look of a product and to its durability so fabric selection is critically important. With so many different textures, colours and finishes being offered in today's marketplace we will work with you to make the best choices for each of our products and ensure that your selection is fit for the intended purpose.

This is an introduction to the key criteria to be considered when selecting the correct fabric.

Wool and Synthetic fabrics – Wool is used in many woven fabrics. Its softness and durability make it the obvious choice for soft seating or large seating units as it recovers well. Synthetic products, such as Polyester and Polypropylene, have a greater stretch and do not recover as well but are highly suitable for certain seating styles. Blends of natural and synthetic fibres often offer the best of both worlds, providing strength and durability as well as softness and ease of handling.

An increasing number of sustainable fabrics are now available, either made from recycled materials or from natural plant-based fibres. If this is an important selection criterion, please let us know and we will advise accordingly, or refer to the Fabric Information sheet on our website 2026-Fabric-Information.xlsx

Vinyls or Faux leathers (synthetic leathers) – Vinyls (PVC – polyvinyl chloride) are commonly used for seating in high use environments such as education and healthcare. Specialist vinyls are available, resistant to blood and urine, antibacterial and antimicrobial treated, inherently FR to medium Hazard and importantly cleanable with diluted bleach-type solutions. The quality of faux leathers now is such that they look like the real thing but have the advantage of offering finishes that have the same characteristics as vinyls.

Fire Retardancy – All fabrics must confirm to either low hazard or medium hazard FR standards, according to the environment in which they are to be used:

Low Hazard	Hotel Bedrooms
Offices	Hospitals
Schools	Public Buildings
Colleges	Restaurants
Universities	Places of Public Entertainment
Museums	Public Houses and Bars
Exhibition	Bingo Halls
Day Centres	
Medium Hazard	

FR treatments are often applied to the fabric when the dyeing process takes place making the treatments integral to the fabric. Alternatively, the FR can be applied as an external coating.

Abrasion resistance – Abrasion is measured by the Martindale abrasion test, which is an industry British Standard and is measured in the forms of 'rubs'. British Standards conformance is for a fabric to achieve 40,000 rubs or more. Vinyls (or synthetic leathers) are also measured by this method or for 'flexing / cracking'.

Many fabrics are already stain repellent but treatments can be added to fabrics to make them more resistant to stains, liquids and general soiling. These treatments are more often used on wool fabrics but are less of a requirement on synthetics (polyesters / polypropylenes) as these yarn are derivatives of plastic and therefore more resistant to staining and soiling.

Anti-microbial qualities and treatments – this issue is more important than ever in all environments and we list below the website links for information from some of the fabric manufacturers for whom this is likely to be a relevant consideration:

- Agua: <https://www.aguafabrics.com/aguaguard365/>
- Camira: <https://www.camirafabrics.com/en/news-and-events/introducing-camira-staysafe>
- Chieftan: <https://chieftainfabrics.com/technical-hub/coronavirus/>
- Panaz: <http://www.panaz.com/en/shieldplus/>

If such properties are relevant to your decision-making process you should research the relevant manufacturers' websites and their technical teams will be more than happy to provide further guidance if necessary.

Fabric groups

MANUFACTURER	Group 0	Group 1	Group 2	Group 3	Group 4	Group 5	Group 6	Group 7	POA
ABBOTSFORD		Classic Plain		Classic Melton	Feast	Texture/ Luxury Weaves	Wool Sateen		
AGUA			Libra	Parody (incl Linen)	Alberta Hyde				
			Linetta	Rizada	Bouclé				
			Segunda	Sark	Furnisoft Breathable				
				Taurus	The 7 Collection (Crib 7)				
				Tones					
CAMIRA	Citadel	Cara	X2	MainLine Plus	Halcyon	Intervene	Patternmaker	Synergy Quilt	Snug
	Target	Upland	Xtreme	Oceanic	Main Line Twist	Yoredale	Revolution		
		Rivet	Quest	Sumi	Monochrome Sett	Resku 2.0	Layer		
		Advantage	Urban	MainLine Flax	Hemp	Craggan Flax			
		Era	Replay	Blazer	24/7 Flax				
				Synergy	Silk				
CHIEFTAIN		Just Colour	Healthcare & Heritage (Casco)	Multistretch	Earthly				
					Protect 7				
GABRIEL					String	Go Uni/ Check/ Couture	Swing	Grain	Gaja
						Twist/ Twist Melange	Atlantic	Capture	Focus/ Melange/ Royal
						Step	Harlequin	Omega	Europost 2
						Just	Contour/ Countour Melange	Fame	Atlantic Square/ Stripe
						Mica	Spin	Athlon	Cubic
						Tonal	Renewed/ Parcel/ Amaze Loop	Future Loop	Savak
							Step Melange	Gaja Classic	Savoy
							Chili	Morph	Comfort+
ILIV			Rio	Compass	Chroma	Aurify	Horizon	Harlow	
			Abbott	Hemsby	Saddle	Milan	Sculpture	Kelso	
				Tahoe	Tahoe	Apollo	Puzzle		
				Lismore	Richmond	Hampton			
				Adley	Solar				
INLOOM	Bondai	Alba	Radio	Time	Milano	Corte	Nabucco		
		One	King Flex	Jet	Spazio				
				Jeans					
KVADRAT							Autumn	Remix 3	Steelcut Quartet
							Steelcut Beat	Hero Heather	Tonus 4
							Hero 2	Tonica 2	Divina Melange 3
							Sport	Fiord 2	Alle
								Steelcut Trio 3	Hallingdal 65
								Steelcut 3	Gentle 2
								Divina 3	Sonar 3
PANAZ		Highland	Cadet	Luxe Performance Velvet	Harvard	Natural Botanic			
		EcoTwist	Soft Touch Pro	Aston	Elkie	Natural Flight			
		Marna	Eve Velvet	Nature	Merlin Velvet	Enchant Velvet			
			Alba	Linear		Indulgence Plain Velvet			
				Highland Stretch					
				Allure Velvet					
ULTRAFABRICS						Ultraleather	Wired		
						Brisa	Ultraleather Pro FR		
						Pearlized	Volar Bio		
VESCOM			Colour Connect	Avon	Dalma	Foster			
			Zenith	Norfolk	Leone Plus	Lamu			
				Acton	Fuga	Wolin			
				Furka Plus	Hestan	Lani			
					Noss				

rhbr is the trading name of Rhubarb Seating Limited

Terms of Business 1 April 2026.

rhbr is the trading name of Rhubarb Seating Limited

Terms of Business 1 April 2026

The following are the terms (“Terms”) on which Rhubarb Seating Limited trading as rhbr (“we” “our” or “us”) have agreed to supply goods (“Goods”) to you (“you” or “your”).

1. Orders

- 1.1. You may place an order for Goods from us only by written form of communication and no orders for Goods submitted by you shall be deemed to be accepted by us unless and until confirmed in writing by us (“Confirmation”).
- 1.2. You shall be responsible for ensuring the accuracy of all the terms of any order and for checking that the Confirmation is correct and no order which we have accepted may be cancelled by you.
- 1.3. These Terms apply to the exclusion of any other terms that you seek to impose.
- 1.4. We reserve the right to discontinue products and change product specifications at any time

2. Delivery

- 2.1. Delivery of the Goods shall be made by us delivering the Goods to your premises in the UK as notified to us at the time of your order or directly, on request, to an end-user in the UK. Unless quoted otherwise, delivery for a single drop with a value in excess of £1,000 within the post codes scheduled in Appendix A is free of charge except for below in respect of fines. Additional charges equivalent to the cost to us for delivery will be payable by you should you specify delivery of the Goods anywhere outside of those post codes or where the delivery incurs tolls, congestion, or other such charges. Delivery charges for drops outside of the post codes scheduled in Appendix A are set out in Appendix B. “Delivery” is defined as 1 man tail gate delivery between the hours of 8.30am and 5.00pm Monday to Friday. Out of hours delivery may be subject to additional charges and must be agreed in writing prior to delivery. The customer must ensure that suitable parking together with an appropriate number of their own staff are able to receive the goods without delaying the vehicle beyond 15 minutes. 15 minutes after arrival at the closest legal parking point, the driver will be entitled to leave and Section 2.5 will apply. Should our drivers incur any traffic penalty fines due to access restrictions we have not been made aware of in writing prior to delivery, the cost of any such penalty will be added to the Goods invoice and will be payable by the Customer within 30 days of invoice.
- 2.2. All goods must be checked for any damage and details of the damage noted in writing before the vehicle leaves.
- 2.3. Any dates quoted for delivery of the Goods are approximate only; we shall not be liable for any customer costs incurred as a result in the delay in delivery of the Goods.
- 2.4. We will use reasonable endeavors to ensure that the quantity, size and description of the Goods delivered conform to those ordered by you, as set out in the Confirmation, although minor variations may occur.
- 2.5. If you fail to take delivery of the Goods then, without prejudice to any other right or remedy available to us delivery of the Goods shall be deemed to have been completed at the time you failed to take delivery; and, (i) we may store the Goods until actual delivery and charge you for the reasonable costs, including insurance and storage; or (ii) we may sell the Goods at the best price readily obtainable and (after deducting all reasonable storage and selling expenses) account to you for any excess over the price payable or charge you for any shortfall below that price.
- 2.6. We may deliver the Goods by instalments, which shall be invoiced and paid for separately. Each instalment shall constitute a separate supply of Goods. Any delay in delivery or defect in an instalment shall not entitle you to cancel any other instalment.

3. Price

- 3.1. The price of the Goods shall be the price agreed when the Goods are ordered from us as set out in the last Confirmation and we will not be responsible for any losses caused to you by reason of fluctuation in currency exchange rates between the date when the Goods were ordered and when they are delivered. All prices quoted are valid only for the particular order which you make.
- 3.2. Subject to clauses 2.1 and 2.2 above, all prices are given by us inclusive of costs of carriage unless otherwise agreed in writing.
- 3.3. All prices are exclusive of value added tax, which you shall be additionally liable to pay to us.

4. Terms of Payment

- 4.1. We shall be entitled to invoice you at any time after delivery or deemed delivery of the Goods and you shall pay the price of the Goods within 30 days of the date of our invoice or on such other terms as are agreed in writing by us or, stated in the Confirmation.
- 4.2. If you fail to make any payment on the due date then, without prejudice to any other right or remedy available to us, we shall be entitled to (i) cancel the order for Goods and suspend any further deliveries to you; and (ii) charge you interest (both before and after any judgment) on any sum until payment in full is made unpaid at the rate of 4% per annum above Barclays Bank Plc base rate from time to time.

5. Risk and Property

- 5.1. The Goods shall be at your risk as from delivery.
- 5.2. The Goods shall not pass from us until (i) we have received payment in full in cleared funds for the Goods plus VAT; and, no other sums whatever shall be due from you to us.
- 5.3. Until title to the Goods passes you shall hold the Goods on our behalf. You shall store the Goods (at no cost to us) separately from all other goods in your possession and marked in such a way that they are clearly identified as our property and shall maintain the Goods in satisfactory condition.
- 5.4. We shall be entitled to recover the full price for any Goods sold under these Terms including VAT, notwithstanding that the title in such Goods has not passed from us.
- 5.5. If (before title to the Goods passes to you) you become subject to any of the events listed in clause 7.1.(ii) – 7.1.(v) or we reasonably believe that any such event is about to happen and notify you accordingly, then, provided the Goods have not been sold, or irrevocably incorporated into another product, and without limiting any other right or remedy we may have, we may at any time require you to deliver up the Goods and, if you fail to do so promptly we may enter any vehicle or premises where the Goods are stored in order to recover them.
- 5.6. You shall not pledge or in any way charge by way of security for any indebtedness any of the Goods which are our property.
- 5.7. You shall insure and keep insured the Goods to their full price against “all risks” to our reasonable satisfaction until the title in the Goods passes from us.
- 5.8. Without prejudice to our other rights, if you fail to comply with your obligations under this clause 5, all sums whatsoever owing by you to us shall immediately become due and payable.

6. Warranties and Liability

- 6.1. Subject to the remainder of this clause 6 and excluding upholstery fabrics not specifically recommended by the manufacturer for the proposed use, we warrant that the Goods will be of satisfactory quality at the time of delivery and against manufacturing defects for a period of 6 years after delivery, with the following exceptions:

- 6.1.1. Goods which are specified to be used for continuous and consecutive periods of 24 hours and Beanbags both of which we warrant against manufacturing defects for a period of 2 years after delivery;
- 6.1.2. Re-upholstery work where the warranty against manufacturing defects is limited to the materials and work for which the Company has been responsible as follows:
 - Upholstery work only: 5 years, reduced to 2 years if replacement of foams has been recommended by us but rejected;
 - Upholstery and replacement foams: 5 years;
 - Upholstery, replacement foams and repair of frames: 5 years.

This warranty does not cover normal wear and tear nor instances of damage through evident mis-use of any sort.

- 6.2. We shall be under no liability under the above warranty in respect of the following matters:-

- 6.2.1. if you make any use of Goods after giving a notice in accordance with clause 6.4, or the defect arises because you failed to follow our verbal or written instructions as to the storage, installation, commissioning, use or maintenance of the Goods or (if there are none) good trade practice, or you alter or repair such Goods without our written consent, or the defect arises as a result of fair wear and tear, willful damage, negligence, or abnormal working conditions;
- 6.2.2. if the production identification label detailing the model, order number and date of production has been removed from the goods
- 6.2.3. if the total price for the Goods has not been paid by the due date for payment;
- 6.2.4. for the condition of Goods which are modified after delivery or for any expenses incurred in connection with such modification
- 6.2.5. If stated in writing prior to delivery.

- 6.3. Subject as expressly provided in these conditions all warranties conditions or other terms implied by statute or common law are excluded to the fullest extent permitted by law.
- 6.4. Any claim by you which is based on any defect in the quality or condition of the Goods must be made in writing to us within 48 hours of receipt of the same otherwise you shall not be entitled to reject the Goods. In the case of a quality dispute the Goods should be retained by you for inspection by us.
- 6.5. Where any valid claim in respect of any of the Goods which is based on any defect in the quality or condition of the Goods is notified to us in accordance with these Terms, we shall be entitled to replace such Goods free of charge or, at our sole discretion, refund to you the price of the Goods, but shall have no further liability to you.
- 6.6. Where a warranty claim is proved to be invalid we shall be entitled to charge an administration fee of £75 plus reasonable costs of collection and delivery of the Goods.
- 6.7. Except in respect of death or personal injury caused by our negligence, our entire liability under or in connection with these Terms shall not exceed the price of the Goods.
- 6.8. Notwithstanding anything else contained in these Terms we shall not be liable to you for loss of profits or contracts, indirect or consequential losses whether arising from negligence, breach of contract or otherwise.

7. Termination

- 7.1. We shall be entitled to terminate the supply of Goods hereunder immediately by written notice to you if (i) you commit any continuing or material breach of any of the provisions of these Terms and, in the case of a breach which is capable of remedy, you fail to remedy the same within 30 days after receipt of a written notice giving full particulars of the breach and requiring it to be

remedied;(ii) an encumbrancer takes possession or a receiver (or similar office holder) is appointed over any of your property or assets; (iii) you make any voluntary (or similar) arrangement with your creditors or an administrator is appointed or you are subject to insolvency proceedings in any jurisdiction; (iv) you go into liquidation (except for the purposes of an amalgamation, reconstruction or other reorganisation and in such manner that the company resulting from the reorganisation effectively agrees to be bound by or to assume the obligations imposed on that other party under these Terms); or (v) you cease, or threaten to cease, to carry on business.

- 7.2. If any of the events set out in clause 7.1 occurs we shall be entitled to cancel the supply of Goods hereunder or suspend any further deliveries without liability to you, and if the Goods have been delivered but not paid for the price shall become immediately due.

8. General

- 8.1. We shall not be responsible for any delays in performing, or for any failure to perform, any of our obligations hereunder if the delay or failure was due to any cause beyond our reasonable control.
- 8.2. If any provision of these Terms is declared by any judicial or any other competent authority to be void, voidable, illegal or otherwise unenforceable or indications to that effect are received by us from any competent authority then that provision shall be limited or eliminated to the minimum extent necessary so these Terms shall otherwise remain in full force and effect and enforceable.
- 8.3. Each party acknowledges that these Terms contain the entire agreement between you and us and that you have not relied on any verbal or written representations made by us or our employees or agents.
- 8.4. These Terms supersede any prior agreement whether written or oral.
- 8.5. Any notice or other information required or permitted to be given under these Terms shall be deemed to have been validly given if served personally on that party or if sent by first class pre-paid post to the last known address of that party. If sent by first class pre-paid post the notice shall be deemed to have been received 2 days after the date of posting. If any such notice or other information is given by means of facsimile then notice shall be deemed to have been received on the same day if sent during normal working hours or on the next working day where sent outside such hours.
- 8.6. No variation of these Terms shall be binding unless made in writing and signed by you and us.
- 8.7. These Terms shall be governed by English law and the English Courts shall have exclusive jurisdiction to decide any dispute concerning these Terms.
- 8.8. No waiver by us of any breach of these Terms by you shall be considered as a waiver of any subsequent breach of the same or any other provisions.
- 8.9. These Terms shall not be enforceable by a person who is not a party to them under the Contracts (Rights of Third Parties) Act 1999 or otherwise.
- 8.10. Our policy is one of continual improvement. We therefore reserve the right to alter designs, dimensions, availability and price without prior notice.

Appendix A: Free delivery

See map for free delivery for single drops of value greater than £1,000 (excluding VAT)

Appendix B: Delivery charges

Unless specifically agreed in writing delivery charges for all deliveries outside the map area in Appendix A above will be dependent on the method of delivery:

- Per van or boxed delivery within the UK mainland
- Per pallet within the UK mainland
- Outside of the UK mainland

Rhubarb Seating
8 Dormer Road
Thame
Oxfordshire
OX9 3UD

01869 326300

sales@rhubarbseating.co.uk